

TEXTE

47/2014

# Understanding the exposure pathways of per- and polyfluoralkyl substances (PFASs) via use of PFASs-containing products – risk estimation for man and environment



ENVIRONMENTAL RESEARCH OF THE  
FEDERAL MINISTRY OF THE ENVIRONMENT,  
NATURE CONSERVATION AND NUCLEAR SAFETY

Project No. (FKZ) 3711 63 418  
Report No. (UBA-FB) 001935/E

## **Understanding the exposure pathways of per- and polyfluoralkyl substances (PFASs) via use of PFASs-Containing products – risk estimation for man and environment**

by

**Thomas P. Knepper, Tobias Frömel, Christoph Gremmel, Inge van  
Driezum, Heike Weil**  
Hochschule Fresenius gem. GmbH, Idstein

**Robin Vestergren, Ian Cousins**  
Stockholm University, Department of Applied Environmental Science  
(ITM), Stockholm, Sweden

On behalf of the Federal Environment Agency (Germany)

**UMWELTBUNDESAMT**

This publication is only available online. It can be downloaded from <https://www.umweltbundesamt.de/publikationen/understanding-the-exposure-pathways-of-per>

The contents of this publication do not necessarily reflect the official opinions.

ISSN 1862-4804

Study performed by: Hochschule Fresenius gem. GmbH  
Limburger Str. 2  
65510 Idstein, Germany

Study completed in: April 2014

Publisher: Federal Environment Agency (Umweltbundesamt)  
Wörlitzer Platz 1  
06844 Dessau-Roßlau  
Germany  
Phone: +49-340-2103-0  
Fax: +49-340-2103 2285  
Email: [info@umweltbundesamt.de](mailto:info@umweltbundesamt.de)  
Internet: <http://www.umweltbundesamt.de>  
<http://fuer-mensch-und-umwelt.de/>

Edited by: Section IV 2.3 Chemicals  
Claudia Staude, Lena Vierke

Dessau-Roßlau, July 2014

## Abstract

The contribution of outdoor jackets as a source of per- and polyfluoroalkyl substances (PFASs) regarding the environmental and human exposure in Germany and other member states of the European Union (EU) has been investigated. Following the development of robust and validated analytical methods for 24 different PFASs, a total of five impregnating agents and 16 different jackets were analyzed.

Jackets were selected depending on e.g. their origin of production, textile, price and market share. In these jackets PFASs were determined in a range between 0.03 and 719  $\mu\text{g}/\text{m}^2$ . In particular perfluorooctanoic acid (PFOA) was omnipresent (0.02 to 171  $\mu\text{g}/\text{m}^2$ ), although at lower concentrations compared to the precursors of perfluoroalkyl carboxylic acids (PFCAs), namely fluorotelomer alcohols (FTOHs) ( $< 1 \text{ ng}/\text{m}^2$  to 698  $\mu\text{g}/\text{m}^2$ ). Perfluoroalkane sulfonic acids (PFSA) and their potential precursors, such as e.g. perfluorooctane sulfonamide (FOSA), were detected at a much lower frequency with concentration up to 5  $\mu\text{g}/\text{m}^2$ .

Environmental exposure routes of PFASs from both, newly bought and freshly impregnated jackets were studied. In particular air emission of volatile PFASs precursors, such as 8:2- and 10:2-FTOH could be quantified; however additional losses having already occurred during storing of the jackets have been postulated. Also the release of PFCAs during washing could be quantified. The detected PFOA concentrations in washing water indicated a complete release of the extractable PFOA amount.

Quantification of the human exposure to PFASs stemming from outdoor jackets showed, that the highest intermediate exposure for the background population was observed for PFOA (0.054  $\text{ng kg}^{-1} \text{ day}^{-1}$ ). This is a factor 3-10 lower than the estimated average intake via diet. However, for populations receiving an occupational exposure in outdoor clothing stores, exposure to outdoor jackets could exceed dietary intake estimates.

Estimating in the worst case scenario for Germany, a surplus in the import of approximately 80 Million PFASs-containing outdoor jackets, these jackets do contribute with an amount of 0.27 kg PFOA as one particular source among many others to the PFASs burden for man and the aquatic environment.

## Kurzbeschreibung

Es wurde untersucht, inwieweit Outdoor Jacken zur Exposition von per- und polyfluorierten Alkylverbindungen (PFASs) in der Umwelt und dem Menschen in Deutschland und anderen EU-Mitgliedsstaaten beitragen. Nach der Entwicklung von Analyseverfahren für 24 verschiedene PFASs, wurden insgesamt fünf Imprägniermittel und 16 Jacken analysiert. Die Auswahl der Jacken erfolgte u.a. nach Herstellungsland, Material, Verkaufsmenge und Preis. In den untersuchten Jacken lagen die gemessenen PFASs Konzentrationen in einem Bereich zwischen 0,03 und 719  $\mu\text{g}/\text{m}^2$ . Neben den in höheren Konzentrationen ( $< 1 \text{ ng}/\text{m}^2$  bis 698  $\mu\text{g}/\text{m}^2$ ) vorkommenden Fluortelomeralkoholen (FTOHs) konnte auch Perfluoroktansäure (PFOA) in allen Jacken in einem Konzentrationsbereich von 0,02 bis 171  $\mu\text{g}/\text{m}^2$  detektiert werden. Perfluoralkansulfonsäuren (PFSA) und deren Präkursoren, wie z.B. Perfluoroktansulfonamid (FOSA), wurden weniger häufig und in Konzentrationen bis zu 5  $\mu\text{g}/\text{m}^2$  gemessen.

Weiterhin wurde u.a. die Freisetzung von PFOA-Präkursoren, wie FTOHs, in die Luft untersucht, wobei davon ausgegangen werden kann, dass sich bereits während der Lagerung der Jacken ein Teil dieser Substanzen verflüchtigt hat.

Die Quantifizierung von perfluorierten Carbonsäuren in das Waschabwasser zeigt eine vollständige Freisetzung für z.B. PFOA.

Die Exposition des Menschen mit PFASs aus Outdoor Jacken wurde errechnet und mit der PFASs-Aufnahme über die Nahrung verglichen. Die höchste Belastung für Menschen wurde für PFOA ( $0,054 \text{ ng kg}^{-1} \text{ Tag}^{-1}$ ) geschätzt, und liegt damit um den Faktor 3-10 niedriger als die geschätzte durchschnittliche Aufnahme über die Nahrung. Höhere Exposition können am Arbeitsplatz in Outdoorgeschäften erreicht werden.

Unter der Annahme, dass die in Deutschland im Importüberschuss eingeführten 80 Millionen Jacken alle PFASs enthalten, konnte ein PFOA-Eintrag von 0,27 kg in die Gewässer errechnet werden. Zusammenfassend konnte somit nachgewiesen werden, dass aktuell Outdoor Jacken zur Umweltbelastung von PFASs und zur Exposition des Menschen beitragen.

## Table of Contents

List of Figures

List of Tables

List of Abbreviations

1	Overview - Objectives of the study.....	12
2	Introduction.....	13
3	Background information regarding production and use of PFASs in textile industry, with focus on DWR textiles and impregnation agents .....	18
3.1	Search strategy.....	18
3.2	Role of PFASs in outdoor jackets.....	18
3.3	Global production volumes of PFASs .....	21
3.3.1	Historical production volumes and use of PFOS.....	21
3.3.2	Production volumes of PFCAs with focus on PFOA.....	22
3.3.3	Production volumes of FTOHs.....	23
3.3.4	Production volumes of fluoropolymers .....	23
3.3.5	Production volumes of side-chain fluorinated polymers.....	24
3.4	Trading and consumption of PFASs with respect to DWR textiles.....	25
3.5	Review of PFASs concentrations in textiles .....	28
3.6	Environmental emissions of PFASs related to textiles.....	29
3.7	Estimation of the quantity of outdoor jackets imported to Germany .....	31
3.8	Measures of the textile industry for sustainable purposes .....	38
3.8.1	Recycling of DWR textiles .....	38
3.8.2	Voluntary control of PFASs related to outdoor jackets.....	39
3.8.3	Assessment of potential PFASs emissions during the production of textiles into the atmosphere, waste water, surface water and soil in the EU production sites. ....	40
3.9	Production of impregnating agents and their PFASs contents.....	42
3.10	Conclusion of literature research .....	43
4	Analysis of PFASs concentrations in outdoor jackets .....	44
4.1	Materials and methods .....	44
4.1.1	Selection of DWR jackets.....	44
4.1.2	Substances and standards.....	47
4.2	Analytical method development and quality assurance .....	49
4.2.1	HPLC methods.....	49



**Understanding exposure pathways of PFASs via use of PFASs-containing products –risk estimation for man and environment**

4.2.2	MS/MS methods .....	49
4.2.3	Sample preparation and extraction of PFAS-a .....	50
4.2.4	Sample preparation and extraction of PFAS-n.....	51
4.2.5	Quantitative method PFAS-f .....	51
4.2.6	Quantification of PFASs in the jackets analyzed.....	52
4.3	Results .....	52
4.3.1	Calibration curves and limits of quantification.....	52
4.3.2	Validation of the PFAS-a extraction method.....	53
4.3.3	Validation of the PFAS-a method with internal standards.....	54
4.3.4	Validation of the PFAS-n extraction method with spiked solvent.....	56
4.3.5	Validation of PFAS-f method .....	57
4.3.6	Results of outdoor jacket analysis .....	58
4.4	Discussion .....	62
5	Analysis of impregnating agents .....	65
5.1	Materials and methods .....	65
5.1.1	Selection of impregnating agents .....	65
5.1.2	Analytical methods.....	65
5.2	Results .....	66
5.3	Discussion .....	67
6	Emissions of PFASs during wearing and cleaning of outdoor jackets: evaporation studies and washing experiments .....	69
6.1	Materials and methods .....	69
6.1.1	General information .....	69
6.1.2	Evaporation studies.....	69
6.1.3	Washing experiments.....	70
6.1.4	Impregnating agents .....	71
6.1.5	Instrumental method.....	71
6.2	Quality control.....	71
6.2.1	Evaporation studies.....	71
6.2.2	Washing experiments.....	72
6.3	Results and discussion.....	72
6.3.1	Evaporation studies.....	72
6.3.2	Washing water .....	75
6.3.3	Release of PFASs from jacket pieces treated with impregnating agents.....	77



## Understanding exposure pathways of PFASs via use of PFASs-containing products –risk estimation for man and environment

7	Environmental exposure.....	80
8	Extrapolation of PFOA amount imported into Germany via DWR jackets .....	84
9	Modeling human exposure to per- and polyfluoroalkyl substances (PFASs) from outdoor clothing and impregnation sprays .....	85
9.1	Methods .....	85
9.1.1	Exposure groups .....	85
9.1.2	Model uncertainty .....	85
9.1.3	Direct and Indirect exposure to PFCAs.....	85
9.1.4	Exposure pathways.....	86
9.1.5	Calculation of total exposure and comparison with dietary exposure .....	91
9.2	Results .....	91
9.3	Relevance of exposure to DWR jackets compared to other exposure pathways.....	97
10	Conclusions, recommendations, scientific impact and outlook .....	99
11	References.....	102
12	Supplement information.....	112
12.1	Major garments.....	112
12.2	Information from “Statistisches Bundesamt” .....	114
12.3	Compilation of studies concerning impregnating agents.....	116
12.4	Environmental Emissions of PFASs.....	119
12.5	Companies involved in textile production .....	119
12.6	Recycling of DWR.....	120
12.6.1	Attempts of companies for Recycling .....	120
12.6.2	Standard substances lists .....	121
12.7	Quantitative measurements in Outdoor jackets .....	124
12.7.1	Method development.....	124
12.7.2	Validation.....	127
12.7.3	Results of DWR jacket analysis .....	129
12.8	Analysis of impregnating agents.....	131
12.9	Analysis of emissions.....	131

**List of Figures**

Figure 1. Terminology of PFASs according to Buck et al. (2011); (Reprinted from OECD, 2013)..... 13

Figure 2. Life cycle of PFASs in outdoor jackets and resulting exposure to humans .....15

Figure 3. Schematic examples of the synthesis and transformation of C<sub>8</sub>-based fluorochemical repellents used for textile finishing and the role of precursors for the formation of relevant PFASs, e.g. PFOA and PFOS a) Fluorotelomer acrylate-based polymer; R<sub>1</sub>, R<sub>2</sub>, and R<sub>3</sub> can be different side groups such as non-fluorinated alkyl chains; b) Perfluorooctane sulfonamide-based polymer (Lacasse and Baumann, 2004). Note that the structures shown are exemplary cutouts of the polymer.....16

Figure 4. Most important import countries for the German textile market in 2011; import value given in 1,000 Euro.....34

Figure 5. Turnover of the leading outdoor-brands in the year 2011 (in millions euro) .....36

Figure 6. Share of DWR jackets among the total number of outdoor jackets in stores including also online-stores in November 2011.....37

Figure 7. Recovery of PFAS-a extraction by sonication for one hour (n=3). Recovery was calculated by a comparison of concentrations determined in spiked and unspiked samples and a calibration curve based on peak areas of the analytes. Peak area ratios relative to internal standards were not used for this calculation. ....54

Figure 8. Recovery results of PFAS-a extraction method with spiked samples (n=2) relative to internal standard, expressing trueness of the method. ....55

Figure 9. Recovery results of PFAS-n extraction method with spiking directly in n-hexane before SPE (n=3). Recovery was calculated by comparison of concentrations determined in spiked and unspiked samples and a calibration curve based on peak areas of the analytes. Peak area ratios relative to internal standards were not used for this calculation. ....56

Figure 10. Replicate determination of PFASs concentration by using the PFAS-n determination method (n=6).....57

Figure 11. Recovery results of FOSA-derivatives by combination of PFAS-n extraction with PFAS-a MS/MS method (n=3).....58

Figure 12. Correlation of concentrations of PFOA with PFNA in investigated jackets.....61

Figure 13. Comparison of detected PFASs concentrations and ratios in DWR jackets; top: full scale, bottom: cut-out.....64

Figure 14. Summary of analytical results obtained for impregnating sprays and comparison to results previously determined; top: full scale, bottom: cut-out.....68

Figure 15. Schematic experimental design of used for evaporation studies.....70

Figure 16. Percentage release of FTOHs from DWR jackets to the air. Percentage released was calculated by dividing the amount of substance volatilized by the

amount determined by solvent extraction (based on $\mu\text{g}/\text{m}^2$ data); error bars show SD [n=2].	74
Figure 17. Percentage release PFASs from DWR jackets during washing. Releases were calculated by dividing the amount released by washing by the amount of solvent-extractable PFASs.	76
Figure 18. Relative importance of consumer product based exposure pathways for background exposed population (a) intermediate exposure (b) high exposure.	95
Figure 19. Relative importance of exposure pathways for occupationally exposed population (a) intermediate exposure (b) high exposure.	96
Figure 20. Comparison of total product related exposure to PFCAs with estimated average dietary intake from Sweden (Vestergren et al., 2012). Solid bars represent the intermediate scenario and positive error bars represent the high exposure scenario.	97
Figure 21. Recoveries of PFCAs and PFSAs in J5 (top) and J6 (bottom) calculated by division of peak areas in extracts with those from solvent standards.	124
Figure 22. Time course of FTOHs and FOSE species after application of a methanolic solution to an open vial showing the decline of FTOHs species by volatilization of the compounds after volatilization of the solvent [n=2].	125
Figure 23. Recovery of internal standards in selected jacket samples comprising all membranes and garments used in this study. Recovery was calculated based on peak area comparison in samples versus average peak area of internal standards in calibration standards.	128
Figure 24. Recovery of M-8:2-FTOH in diluted impregnating agents and wash-in impregnating agents without SPE.	131

**List of Tables**

Table 1. List of key PFASs classes within this study.....18

Table 2. Global historical PFCA Production and Emissions Summary (modified from Prevedouros et al., 2006). .....23

Table 3. Estimated consumption of PFOS, PFOA and selected precursors in the Swiss textile industry (FOEN, 2009). .....26

Table 4. Extractable PFASs from different textile samples summarized in groups ( $\mu\text{g}/\text{m}^2$  textile). .....28

Table 5. Literature PFASs concentrations in outdoor and indoor air reported in the literature. All concentrations are given in  $\text{ng}/\text{m}^3$ . .....31

Table 6. Compilation of anoraks and windbreaker; given are number of pieces and weight; data obtained from the Statistisches Bundesamt, Germany for the years 2009, 2010 and 2011. ....33

Table 7. Compilation of trade working gear, men, for Germany given in t weight; data given from the Statistisches Bundesamt, Germany for the years 2009, 2010 and 2011.....33

Table 8. Textile and clothes market in the “Non-Textile-Trade” in Germany from 2009-2010; (Turnover in million euro). .....35

Table 9. Top 10 sales number in German sports shops exemplarily taken for the calendar weeks (cw) 23./37./39. in 2011, and 41. in 2010; .....37

Table 10. Reported emissions and product content of PFOA, precursors, and higher homologues from non-US operations from 2008; data retrieved from USEPA (2008).....41

Table 11. Tested outdoor jackets, J0-J15, information concerning function, membrane, origin etc. ....45

Table 12. List of investigated substances and the corresponding LC-MS/MS method .....47

Table 13. List of certified PFASs standards. ....48

Table 14. HPLC gradient profile of the PFAS-a HPLC method. ....49

Table 15. HPLC gradient profile of the PFAS-n HPLC method.....49

Table 16. Overview of quantifier and qualifier transitions, internal standards attributed to target analytes as well as retention times of target compounds for PFAS-a HPLC-MS/MS method. ....50

Table 17. Overview of quantifier and qualifier transitions, internal standards attributed to target analytes as well as retention times of target compounds for PFAS-n HPLC-MS/MS method. ....50

Table 18. Overview of limits of quantification (LOQ) for DWR jackets. ....52

Table 19. Relative standard deviation (RSD) of the measured extract from a spiked sample of jacket J7 on two different days, extracted and analyzed with PFAS-a quantification method. ....55

**Understanding exposure pathways of PFASs via use of PFASs-containing products –risk estimation for man and environment**

Table 20. Concentration of PFASs in analyzed outdoor jackets; Jacket No ( $\mu\text{g}/\text{m}^2$ , n=2). .....	60
Table 21. Concentrations determined in impregnation agents (in $\mu\text{g}/\text{mL}$ ); n.d .= not detected. ....	66
Table 22. Experimental setup of evaporation studies performed with the pieces of jackets J2, J8, J10 and J14.....	70
Table 23. LOQ and LOD for neutral PFASs for evaporation studies. ....	71
Table 24: Average blank values in methanolic eluates from cartridges used for flow-through studies of volatile PFASs.....	73
Table 25. Airborne concentrations of neutral PFASs from DWR jackets after a 5-day evaporation study expressed as $\mu\text{g}$ substance per kg jacket.....	73
Table 26. Airborne concentrations of neutral PFASs from outdoor jackets after an additional 2-day evaporation study.....	74
Table 27. Percentage relative release of volatile PFASs from DWR jackets by evaporation. ....	75
Table 28: Blank concentrations of PFASs in washing water. Substances not mentioned were not detected.....	76
Table 29. Relative release of PFASs from DWR jackets J2, J8, J10 and J14 after washing. Releases are given in percentages and are based on the ratio between the expected amount of the compounds and the amount found in the washing water. ....	77
Table 30. Amount of PFASs released in washing water following the impregnation of jacket pieces with I1. The amount of PFASs is given in $\mu\text{g}$ . ....	79
Table 31. Predicted environmental air load for the neutral PFASs. The environmental load was calculated using equation 1. Scenario 1 was based on a sales number of 22 million, scenario 2 used a sales number of 44 million, and scenario 3 used a sales number of 88 million DWR jackets. ....	81
Table 32. Predicted environmental washing water load for PFASs. The environmental load was calculated using equation 1. Scenario 1 was based on a sales number of 22 million, scenario 2 on a sales number of 44 million, and scenario 3 a sales number of 88 million DWR jackets.....	82
Table 33. Calculated consumer product exposure to PFCAs ( $\text{ng kg}^{-1} \text{ day}^{-1}$ ) from DWR jackets for background and occupationally exposed populations estimated with low-exposure, intermediate and high-exposure scenarios. ....	93
Table 34. Total exposure of FTOHs ( $\text{ng kg}^{-1} \text{ day}^{-1}$ ) from the use of DWR outdoor jackets for background and occupationally exposed populations estimated with low-exposure, intermediate and high-exposure scenarios. Values in brackets refer to the estimated indirect exposure to the corresponding PFCAs homologues using estimated biotransformation factors as explained in section 9.1.3.....	94
Table 35. Mixtures containing fluorinated chemicals.....	114
Table 36. Textile-finishing products.....	115

**Understanding exposure pathways of PFASs via use of PFASs-containing products –risk estimation for man and environment**

Table 37. Concentration of PFASs in impregnating agents; (taken from Fiedler et al., 2010; Herzke et al., 2009; Norin and Schulze, 2007; Vejrup et al, 2002).....	116
Table 38. Release and offsite transfer of surveyed PFASs (tonnes), from OECD, 2011. ....	119
Table 39. Companies involved in the textile production for Patagonia. ....	119
Table 40. Oeko-Tex 100 Limit values/issue 01.01.2011 .....	121
Table 41. Blue Sign Standard substances list, fluorinated substances, part 1.....	122
Table 42. Blue Sign Standard substances list, fluorinated substances, part 2.....	123
Table 43. Calibration equations and correlation coefficients of LC-MS/MS calibration curves. ....	127
Table 44: Concentrations of PFASs in outdoor jackets expressed in $\mu\text{g}/\text{kg}$ ; standard deviation (n=2) in brackets .....	129
Table 45: Recovery of PFAS-n (100 ng/mL) spiked to the eluates of evaporation tests (n=2) to determine trueness .....	131
Table 46. Individual data for evaporation studies using J14 and . Concentrations given in ng/mL in the SPE eluates. Flask A and B refer to duplicate measurements; Air was collected for 5 days. ....	132
Table 47. Individual data for evaporation studies using J14 and. Concentrations given in ng/mL in the SPE eluates. Flask A and B refer to duplicate measurements; SPE1 was collected for 5 days, SPE2 was collected for a further 2-day period.....	132
Table 48: LOQs and LODs for PFAAs in washing water; high values are a result of high background signals in the washing water .....	133

## List of Abbreviations

APFO	Ammonium perfluorooctanoate
BAT	Best available technique
CEH	Chemical Economics Handbook
d.w.	Dry weight
DWR	Durable water repellent
ECTFE	Ethylene-chlorotrifluorethylen
EOG	European Outdoor Group
EtFASEs	N-Ethyl perfluoroalkane sulfonamidoethanols
EU	European Union
FASAs	N-Alkyl perfluoroalkane sulfonamides
FASEs	N-Alkyl perfluoroalkane sulfonamidoethanols
FEP	Perfluorethylen-propylen
FOEN	Swiss Federal Office for the Environment
FOSA	Perfluorooctane sulfonamide
8:2-FTA	8:2-Fluorotelomer acrylate
8:2-FTMA	8:2-Fluorotelomer methacrylate
n:2-FTOH	n:2-Fluorotelomer alcohol
FTOHs	Fluorotelomer alcohols
GfK	Gesellschaft für Konsumgüterforschung
IS	Internal standard
kt	Kilotonnes
LOD	Limit of detection
LOQ	Limit of quantification
M-	Mass-labeled internal standard
MeOH	Methanol
MRM	Multiple reaction monitoring
MS	Mass spectrometry/mass spectrometer
MS/MS	Tandem mass spectrometry/tandem mass spectrometer
MW	Molecular weight
n.a.	Not analyzed
n.d.	Not detectable
N-EtFOSA	N-Ethyl perfluorooctane sulfonamide
N-EtFOSE	N-Ethylperfluorooctane sulfonamidoethanols



## Understanding exposure pathways of PFASs via use of PFASs-containing products –risk estimation for man and environment

N-MeFASAs, N-EtFASAs	N-Alkyl perfluoroalkane sulfonamides
N-MeFASEs, N-EtFASEs	N-Alkyl perfluoroalkane sulfonamidoethanols
N-MeFOSA	N-Methyl perfluorooctane sulfonamide
N-MeFOSE	N-Methylperfluorooctane sulfonamidoethanols
NGO	Non-governmental organization
NILU	Norwegian Institute for Air Research
OECD	Organisation for Economic Co-operation and Development
PFA	PTFE-perfluoroalkoxy-copolymer
PFAAs	Perfluoroalkyl acids
PFASs	Perfluoroalkyl and polyfluoroalkyl substances
PFBS	Perfluorobutane sulfonic acid
PFC	German abbreviation for per- and polyfluorinated chemicals
PFCAs	Perfluoroalkyl carboxylic acids
PFDA	Perfluorodecanoic acid
PFDoDA	Perfluordodecanoic acid
PFDS	Perfluorodecane sulfonate
PFHpA	Perfluoroheptanoic acid
PFHxA	Perfluorohexanoic acid
PFNA	Perfluorononanoic acid
PFOA	Perfluorooctanoic acid
PFOS	Perfluorooctane sulfonic acid
PFSAs	Perfluoroalkane sulfonic acids
PFT	Perfluorinated tensides (former German expression for non-polymeric PFASs)
PFUnDA	Perfluorundecanoic acid
POSF	Perfluorooctane sulfonyl fluoride
ppm	Parts per million
PTFE	Polytetrafluoroethylene
PU	Polyurethane
PVC	Polyvinylchloride
PVDF	Polyvinylidene fluoride
QqQLT	Hybrid triple quadrupole linear ion trap tandem mass spectrometer
RSD	Relative Standard Deviation

**Understanding exposure pathways of PFASs via use of PFASs-containing products –risk estimation for man and environment**

SceBRA	Scenario-Based Risk Assessment
SD	Standard deviation
SNF	Swedish society for Nature Conservation, Svenska Naturskyddsföreningen
SPE	Solid-phase extraction
SVHC	Substance of very high concern
TPs	Transformation products
WDR	West-Deutscher Rundfunk
WW	Wastewater
WWTP	Wastewater treatment plant
UBA	German Federal Environmental Agency, Umweltbundesamt

## 1 Overview - Objectives of the study

The potential of outdoor jackets as a source of perfluoroalkyl- and polyfluoroalkyl substances (PFASs) regarding the environmental and human exposure in Germany and other member states of the European Union (EU) has been investigated. In summary, the following goals with focus on Germany and EU have been covered:

- Literature review and evaluation of the kind and use of PFASs in textile industry including the production as well as the impregnation process in the use phase of textiles.
- Literature review and evaluation of manufacturing processes and production sites of outdoor jackets, with special focus on durable water repellent (DWR) jackets, which may contain PFASs, combined with an assessment of potential PFASs emissions into the environment during the production.
- Estimation of the quantity of outdoor jackets imported to the EU (exemplary for Germany).
- Extrapolation of the annual import volume of PFOA to Germany and EU due to the import of outdoor jackets.
- Summarizing the current knowledge on the recycling status of outdoor jackets.
- In order to come up with reliable and validated analytical data, above all, analytical methods were developed and applied for the quantitative analysis of the selected PFASs in outdoor jackets, impregnating agents used for jackets, washing water samples stemming from household washing of selected outdoor jackets, as well as air samples retrieved by the experimental simulation of PFASs emission into the air.
- Selection and purchasing of representative outdoor jackets and impregnation sprays in order to determine the PFASs levels.
- Estimation of the emission of relevant PFASs from selected outdoor jackets – newly bought as well as additionally impregnated - on the basis of simulations of carrying, storage and washing.
- Calculation of the flux of PFASs, particularly PFOA, from washing of outdoor jackets into a wastewater treatment plant (WWTP) and from thereof into surface waters in Germany.
- Estimation of atmospheric PFASs emissions from outdoor jackets, mainly the DWR jackets treated with fluorochemical repellents for Germany.
- Quantification of human exposure to PFASs from outdoor jackets and comparison with other exposure pathways in order re-examine the relative importance of these consumer products for the overall human exposure including occupational exposure in outdoor clothing stores.
- Modeling exposures to PFASs from outdoor jackets for background and occupationally exposed populations and subsequently comparing these with dietary intake estimates derived for the Swedish population.

## 2 Introduction

Perfluoroalkyl and polyfluoroalkyl substances (PFASs) are a class of chemicals where at least two aliphatic carbons bear fluorine in place of hydrogen (Knepper and Lange, 2012). They have been manufactured in increasing quantities since the 1950s (Buck et al., 2011). With increasing chain length the persistent perfluoroalkyl moiety provides surface active, hydrophobic and oleophobic properties to the molecule.

These properties made them useful as industrial process chemicals, e.g. polymerization aids, firefighting foams, metal plating, cleaning agents and in consumer product applications such as textile, carpet and paper treatment for water and grease repellency (Buck et al., 2011).

As summarized in Figure 1 (OECD, 2013), PFASs can be divided in two main categories, the non-polymeric and polymeric PFASs.

Figure 1. Terminology of PFASs according to Buck et al. (2011); (Reprinted from OECD, 2013).

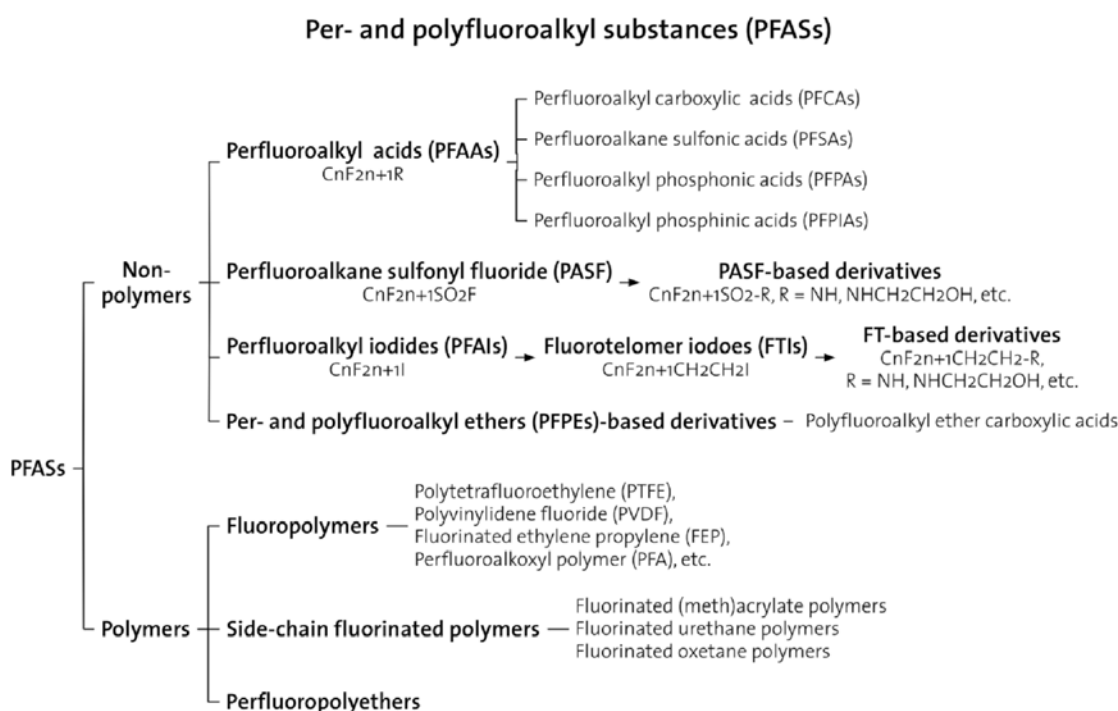

In this study particular attention has been directed to the non-polymeric PFASs, namely to perfluoroalkyl carboxylic acids (PFCAs) and perfluoroalkane sulfonic acids (PFSAs) belonging to the class of the perfluoroalkyl acids (PFAAs), to fluorotelomer alcohols (FTOHs), (*N*-alkyl) perfluoroalkane sulfonamides (FASAs) and (*N*-alkyl) perfluoroalkane sulfonamidoethanols (FASEs) (Table 1).

The reason for that is that PFSAs and PFCAs have been found to be globally present in the environment (Prevedouros et al., 2006; Stock et al., 2007), in wildlife (Giesy and Kannan 2001; Martin et al., 2004) and human serum samples (Hansen et al., 2001; Houde et al., 2006). These compounds are also associated with a range of toxicological effects in animal models (Lau et al., 2007).

In terms of synthetic polymeric PFASs, it is differentiated between fluoropolymers, e.g. polytetrafluoroethylene (PTFE), side-chain fluorinated polymers, such as e.g. fluorinated (meth)acrylate polymers and perfluoropolyethers.

Due to the growing concern among scientists and regulatory bodies regarding adverse environmental and human health effects resulting from the exposure to non-polymeric PFASs, data for regulation purposes have been collected and evaluated. Consequently, perfluorooctane sulfonic acid (PFOS) has also recently been classified as a persistent, bioaccumulative and toxic substance under the United Nations Environment Programme Stockholm Convention on Persistent Organic Pollutants, and included under Annex B (Wang et al., 2009). The regulation by the EU defines the ban of PFOS if the amount (i) in preparations is equal to or higher than 0.001% mass (EU, 2010), (ii) in semi-finished goods or in parts of such goods is equal to or greater than 0.1% of mass, and (iii) for textiles or other coated materials, is equal or higher than 1 µg/m<sup>2</sup> of the coated material (EU, 2010).

Primarily two types of substances have replaced PFOS related substances, namely FTOH-derived substances and PFASs with perfluorinated alkyl chains with less than eight fluorinated carbon atoms, e.g. perfluorobutane sulfonic acid (PFBS) (KEMI, 2006). PFBS related compounds have been produced by 3M company since 2002 (KEMI, 2006).

At present regulations are under development in several countries also for perfluorooctanoic acid (PFOA) due to its toxicity, extreme persistence and accumulation potential (Vierke et al., 2012). The Member States of the EU identified the following PFASs as Substances of Very High Concern (SVHC) according to Art. 57e) of the European Chemicals Regulation (REACH EC 1907/2006):

- C<sub>11</sub>-C<sub>14</sub> PFCAs as very persistent, very bioaccumulative (vPvB)
- PFOA and its ammonium salt ammonium perfluorooctanoate (APFO) as persistent, bioaccumulative and toxic compounds (PBT)

These substances have been added to the REACH Candidate List. Manufacturers and importers are legally obligated to provide information on the use of these substances within the supply chain and to inform the European Chemicals Agency if their manufactured or imported products contain more than 0.1% of the substances. Moreover consumers have the right to receive information about SVHCs in consumer products upon request.

Human exposure to these compounds has been shown to occur via food consumption, inhalation of house dust, and dermal contact (Trudel et al., 2008). Exposure to PFASs via food and drinking water is considered the primary pathway for human intake (Fromme et al., 2007).

Another possible route of human exposure to PFASs, which has not been researched thoroughly, is via the use of textiles. The presence of PFASs in textiles and impregnation agents has already been reported (Berger and Herzke, 2006; Schulze and Norin, 2006; Herzke et al., 2012).

Exposure of humans and the environment to PFASs related to outdoor jackets, mainly DWR jackets containing fluorochemical repellents, may occur directly during the production process or during use. Volatile PFASs may be emitted into the air, whereas water soluble PFASs can be introduced into the water cycle either caused by rain events or during washing. After several washing cycles, the jacket might be impregnated with impregnating sprays or washed with impregnating detergents in order to renew the repellency of the outer fabric. These

impregnating agents contain PFASs (Vejrup and Lindblom, 2002) and can therefore be another source for both, environmental and human exposure. After wearing, some outdoor jackets may be recycled or will be disposed (Figure 2).

Figure 2. Life cycle of PFASs in outdoor jackets and resulting exposure to humans

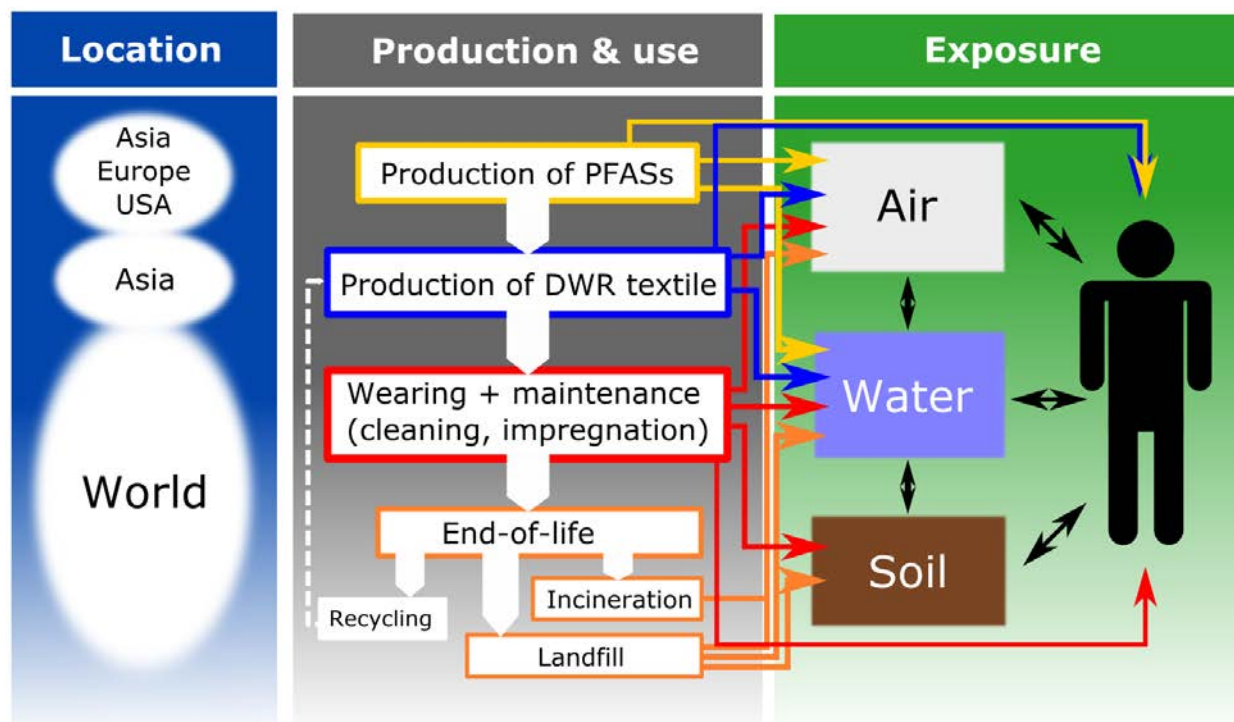

It has been described in the literature that polyfluorinated PFASs such as e.g. the FTOHs and the polyfluoroalkyl ether carboxylic acids can be transformed to persistent PFCAs and PFASs under various conditions (Ellis et al., 2004; Wang et al., 2005; Martin et al., 2005; De Silva et al., 2006; Frömel and Knepper, 2010). Thus an additional source for the ubiquitously detectable occurrence of PFAAs in humans and the environment is the transformation of different polyfluorinated precursors. Most likely these might be some of the polyfluorinated intermediates used for the production of side-chain fluorinated polymers, or even residues from breaking down the polymer itself. The chemical company 3M estimated already in the year 2000 that 85% of indirect emissions of polyfluorinated precursors degrading to stable PFASs are a result of losses from consumer products during production, use and disposal (3M, 2000a).

In Figure 3 the potential life cycle of two different C<sub>8</sub>-based side-chain fluorinated polymers has been schematically drawn. Fluorotelomer- and perfluoroalkane sulfonyl fluoride - based side-chain fluorinated polymers have been in use for over half a century and have been incorporated into a vast array of products, such as carpets, paper coatings, and textiles (Kissa et al., 1997).

Figure 3. Schematic examples of the synthesis and transformation of C<sub>8</sub>-based fluorochemical repellents used for textile finishing and the role of precursors for the formation of relevant PFASs, e.g. PFOA and PFOS a) Fluorotelomer acrylate-based polymer; R<sub>1</sub>, R<sub>2</sub>, and R<sub>3</sub> can be different side groups such as non-fluorinated alkyl chains; b) Perfluorooctane sulfonamide-based polymer (Lacasse and Baumann, 2004). Note that the structures shown are exemplary cutouts of the polymer.

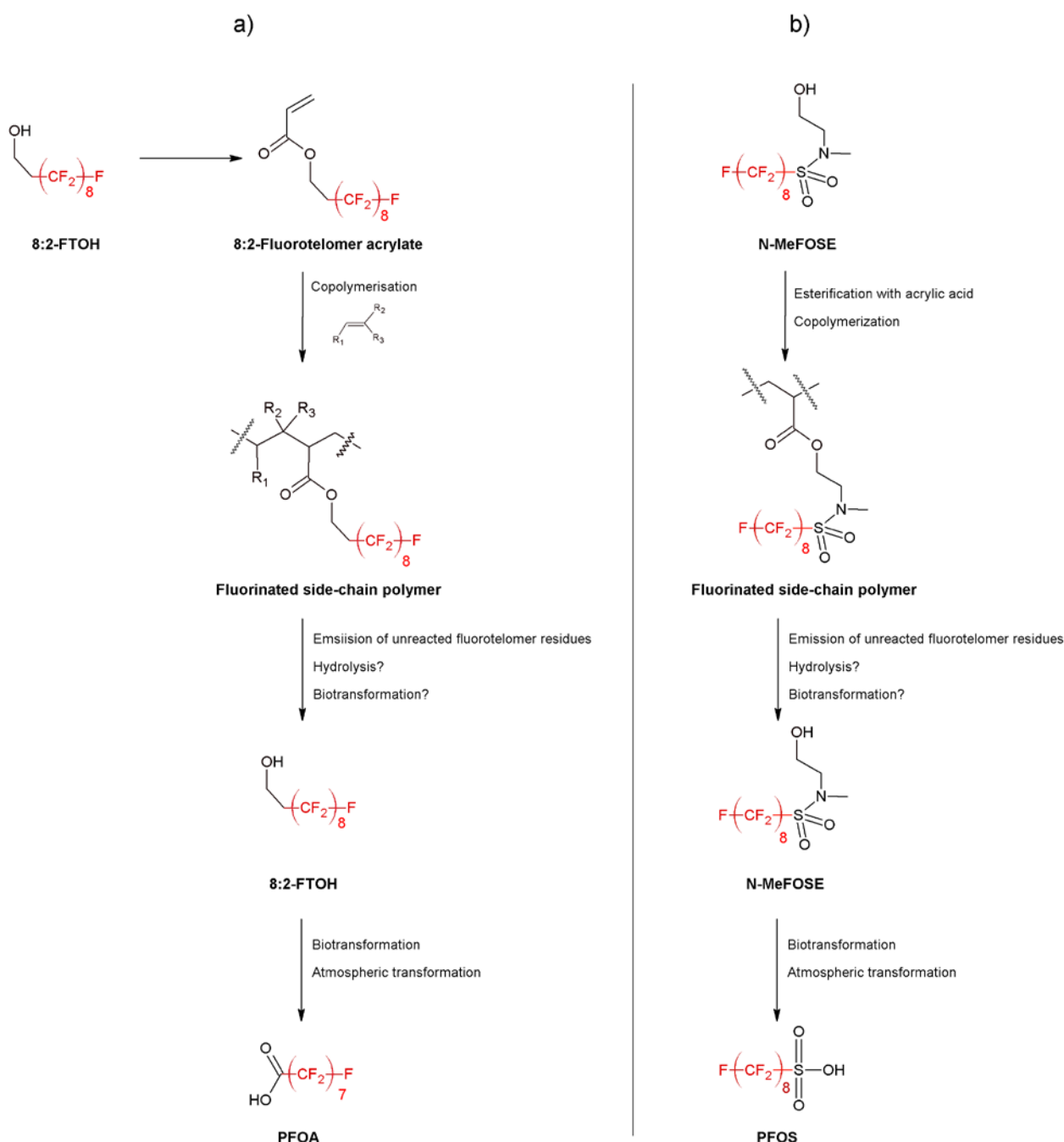

FTOHs are one of the commercially important building blocks used to synthesize side-chain fluorinated polymers (Figure 3). These polymers deliver unique surface modification properties including water and oil repellency (Kissa et al., 1997) and are especially used in DWR clothing (Dinglasan-Panlilio and Mabury, 2006).

As FTOHs have a relatively high volatility and vapor pressure, they can be found in the atmosphere (Martin et al., 2002) and in indoor air samples (Jahnke et al., 2007b; Shoeib et al., 2007).



2011; Schlummer et al., 2013). Since 8:2-FTOH can be transformed both, in the atmosphere (Wallington et al., 2006) and in soil and waste water (Wang et al., 2005, Ahrens et al., 2011) to form PFOA, an indirect exposure to PFOA via these routes is possible.

In order to test the hypothesis that PFASs stemming from the production and use of outdoor jackets might enter the environment and thus contribute to the environmental and human exposure, the present study has been conducted. Thereby, exemplarily for Germany, outdoor jackets and impregnation agents were investigated as a potential source of PFASs. Thereby special emphasis was put on the chemical substance PFOA.

One major goal of the project was the acquisition of different outdoor jackets, such as hardshell and softshell jackets as well as rain jackets. However, since those terminologies are not used in a stringent way by the various producers, especially in case of “no-name-products” and not in all cases water repellency values are indicated on the product tag, a differentiation among the individual jackets was not a goal of this project. Even if named as apparel or DWR textile, it does not automatically lead to the chemistry of these textiles. Since additionally all investigated products were treated anonymously, all investigated jackets are grouped as outdoor jackets within this report.

### 3 Background information regarding production and use of PFASs in textile industry, with focus on DWR textiles and impregnation agents

#### 3.1 Search strategy

Publicly available information from scientific literature, existing studies in Germany and other European member states or non-governmental organizations (NGOs) has been compiled and evaluated to answer the study's questions. The selected classes of key PFASs, deemed relevant for this report are listed in Table 1. According to Figure 1, the classes of the N-Alkyl perfluoroalkane sulfonamides and sulfonamidoethanols as well as the fluorotelomer alcohols, being building blocks of the relevant polymeric PFASs can be considered as precursors for the PFASs and PFCAs.

Table 1. List of key PFASs classes within this study.

Name	Acronym
Perfluoroalkyl carboxylic acids	PFCAs
Perfluoroalkane sulfonic acids	PFSA
Perfluoroalkane sulfonamides	FASAs
<i>N</i> -Alkyl perfluoroalkane sulfonamides	N-MeFASA, N-EtFASA
<i>N</i> -Alkyl perfluoroalkane sulfonamidoethanols	N-MeFASE, N-EtFASE
n:2-Fluorotelomer alcohols	n:2-FTOHs <sup>a)</sup>

a) Individual FTOH homologues are named by the number of carbons that are fluorinated versus the number that are hydrocarbon-based. For example, 8:2-FTOH would represent a molecule with eight fluorinated carbons and an ethylalcohol group.

Information regarding the use of PFASs in textiles and garments and detailed specification of PFASs used by different manufacturers has been researched as follows:

- Study of previous research done in the field of PFASs, such as sources, fate and human exposure via literature search of relevant publications.
- Several websites of both the manufacturers of outdoor textiles, their individual producers of the apparels and the chemical companies producing PFASs and/or textile chemicals have been systematically analyzed.
- For the provision of background information and answers to specific questions, outdoor specialists and producers of PFASs have been consulted.
- Data regarding the type and amount of sold DWR jackets has been compiled on the basis of evaluation in outdoor and sport stores in the Rhine-Main area, Germany.
- Additionally, information from the German Federal Statistical Office as well as direct contact with fluorochemical manufacturers and textile producers has been taken into account.

#### 3.2 Role of PFASs in outdoor jackets

Fluoropolymers and side-chain fluorinated polymers are used in many types of products which utilize their properties of creating smooth, water-repellent, grease-repellent and dirt-repellent surfaces (Lacasse and Baumann, 2004). Information about the use of polymeric PFASs in different products was mainly found on internet web pages from various outdoor jacket

manufacturers, but also by contacting stores, suppliers, importers and producers of PFASs and products containing these compounds. These data had to be combined with official statistics of sales of different products in order to estimate the use of PFASs in different outdoor jackets. However, the available literature from European countries was almost exclusively from Denmark, Sweden, Switzerland and Germany.

PFASs are generally used in leisure clothes for their breathable, water repellent functions and dirt repellency (Kemi, 2006). According to the search within the individual company webpages found in the internet, almost every trademark profiled towards the sports market or the fashion market has outer garments, jackets and trousers which exhibit such breathable and water repellent functions. These water-repellent and dirt-repellent textiles, such as outdoor jackets, often consist of several layers. Thereby the designed feature of both, water resistance and ability to breathe is given by ultrathin membranes with a share of about 40 g per jacket (TEGEWA & FCI, 2007). These membranes might for example be made of microporous polytetrafluorethylene (PTFE) or breathable polyester-polyether-copolymers. The microscopic pores are large enough for body moisture to pass through, but small enough to keep water droplets out (TEGEWA & FCI, 2007). Membrane waterproof jackets with a PTFE membrane construction are for example GORE-TEX® (W. L. Gore & Associates, 2014a) and eVent® (eVent Fabrics, 2013). PTFE is regarded as a stable fluoropolymer and is not included in the group in focus here, but during the manufacture of fluoropolymers, including Teflon®, PFAAs are used as a processing aid and residual quantities may remain in the polymers produced or can be emitted during the production process (Begley et al., 2005).

Most microporous membranes are laminated to an outer, more robust layer, the face fabric (TEGEWA & FCI, 2007). The outer layer might be additionally treated with side-chain fluorinated polymers (Lacasse and Baumann, 2004). The water repellent coating is applied directly on the fibers. There are several techniques for this kind of finishing process. With an increasing share of this finishing treatment the repellency increases leading to a higher water protection (personal communication DWR textile producer).

In contrary to that, coated waterproof jackets contain fabrics, which are coated with durable water resistant materials or similar layers with no breathable membrane. Thereby a protective wall against water droplets is formed on the outer layer. During the coating treatments, which are mainly used for synthetic fabrics, a film made of either silicone or PFASs repellents are applied on the fiber (Lacasse and Baumann, 2004.)

In Figure 3 typical structures of side-chain fluorinated polymers, as can be used in the finishing process are shown. The molecular weight (MW) of such a poly(meth)acrylic copolymer containing polyfluorinated and non-fluorinated side chains is generally above 20,000 Da. A typical water based formulation contains 20 - 30% active polymer compound with fluorine content in the range of 20 - 50% (Schröder, 2009; Dinglasan and Mabury 2006).

A detailed description of all, the textile manufacturing process, as well as the description of various textile finishing steps including the description of various textile chemicals can be found in the book “Textile Chemicals – Environmental Data and Facts” by Lacasse and Baumann (2004). In the following a brief summary of the various information deemed necessary for understanding the textile chemistry of outdoor jackets is given.

The general three steps in the textile manufacturing process are yarn and fabric formation, fabric finishing and fabrication. Fabric formation with the spun yarn is started by e.g. knitting

and weaving. A description of major garments can be found in the supplement information (Chapter 12.1).

The finishing treatments in order to impart the appearance can take place at different stages of the production process, depending for example on the design of textile products that have to be treated. The term finishing treatments depicts techniques such as dyeing, printing, and pre-treatment methods. Before the actual fabrication, the textile can be chemically treated with repellents in order to repel or attract foreign matter from textile surfaces. The improvement of the performance such as water, dirt and oil repellency, softness, durability, etc., is not a standard sequence of treatments, but rather a combination of unit processes depending on the requirements of the final user.

Examples of different repellents used are reactive quaternary, organometallic, resin-based and side-chain fluorinated polymer repellents (Lacasse and Baumann, 2004). The general mode of action and application facts of some of the present marketed repellents such as e.g. Scotchgard<sup>®</sup>, Zepel<sup>®</sup>, Teflon<sup>®</sup>, Persistol<sup>®</sup> and Repellan<sup>®</sup> can be retrieved from the individual product descriptions. However, unfortunately no information regarding the exact chemical constitution of the active ingredients can be obtained.

As stated by Lacasse and Baumann (2004) fluorochemicals are the most commonly used repellents in textile industry due to their additional effect on oil and dirt repellency. These repellents are mainly copolymers of fluoroalkyl acrylates and methacrylates (Figure 3). To modify the physical properties of the polymers and to improve performance, the functional groups attached to the co-monomers are a variation of alkyl and substituted alkyl groups. According to Lacasse and Baumann (2004), for best repellency achieved with side-chain fluorinated polymers, at least four fully fluorinated carbon atoms should be present and the end group should be trifluoromethyl. The side-chain fluorinated polymers are introduced together with emulsifiers, such as ethoxylated fatty alcohols and acids, fatty amines and alkylphenols (Lacasse and Baumann, 2004).

The finishing treatment can make the fabric either completely waterproof or water repellent. The principle of the treatment however, is the same. Water repellents and insoluble compounds can be introduced into the fibers, or the textile can be coated. Water repellent textiles are in general still permeable to air and vapor (Lacasse and Baumann, 2004).

The side-chain fluorinated polymers are applied as a thin film on the fabric surface, usually in combination with other finishing auxiliaries, by a pad-dry-cure process (Lacasse and Baumann (2004). In this process, the dry fabric is passed through a bath of the aqueous dispersion (foulard application), and then squeezed under high pressure between pads to remove excess material, followed by drying and curing in the oven at temperatures up to 180°C. The term drying is used for the evaporation of the solvent, whereas curing is a synonym for the polymerization of the individual monomers. Curing is mandatory for cross-linking techniques (Fischer et al., 2006, Lacasse and Baumann, 2004).

Fluorocarbon dispersions contain besides fluoroacrylate various other comonomers and auxiliaries. Fluoroacrylate is responsible for oil and water repellency. Fluorocarbons mostly contain long-chain fatty alcohol acrylates (see Figure 3) which increase water repellency. Other frequently used comonomers to increase e.g. soil repellency are vinyl and vinylidene chloride, methyl methacrylate and acrylonitrile. In some products fluorinated urethane structures are used for additional effects, such as oil repellency (Lacasse and Baumann, 2004).

During the finishing process, the side-chain fluorinated polymer are bound and fixed in a 0.2 to 0.5 weight%-range to the fiber. This results in a typical total fluorine concentration on the fabric ranging between 0.04% and 0.25% (Fischer et al., 2006).

The polymeric PFASs are chemically bound to the textile surface in such a way, that they remain fixed even after many washing cycles (Schröder, 2009). However, it is generally acknowledged, that the treated outer fabric of the textile loses its water repellency with the increasing number of washing cycles. There are several unpublished hypotheses which have not been scientifically confirmed so far, for example that the surface active compounds of the washing detergents might intercalate within the polymeric PFASs layer. Treating the fabric with impregnating agents will enhance again the repellency of the outer fabric.

According to Schröder (2009), the applied polymeric PFASs may contain FTOHs and PFOA as unreacted side-products. Quantitative investigations performed on the FTOH content of two side-chain fluorinated polymers gave values of approx. 0.1% (Eschauzier, 2012).

KEMI stated in 2006 (KEMI, 2006) that the use of FTOHs in different types of clothes, also T-shirts and trousers made of cotton or polyester are growing globally. In the same report it was further stated that fluorinated side-chain tails (Figure 3) can be released from polymers and/or that impregnating agents contain unreacted residual fluorinated monomers (KEMI, 2006). Both statements are further addressed within the present study.

Because of the European regulations, it may be expected that PFOS in textiles should not exceed concentrations above  $1 \mu\text{g}/\text{m}^2$  of the coated material (EU, 2010). Data from the Swedish products register show a clear drop in the use of PFOS-related compounds in the Swedish textile industry already for the period from 1999 until 2004 (Schulze and Norin, 2006) reflecting the phase out of the major manufacturer 3M. Tests of outdoor jackets have been carried out and traces of PFOS and PFOS derivatives have been measured. Due to the low concentrations found it was concluded by the authors that PFOS was probably not intentionally used, but might be a contaminant stemming either from other chemicals being added or even the textile manufacturing machines (Schulze and Norin, 2006).

### 3.3 Global production volumes of PFASs

This chapter deals with both production volumes and use of those PFASs deemed relevant for the present study. This includes historical data of PFOS and its precursors and the most relevant production data of PFCAs and FTOHs in comparison to retrievable information related to side-chain fluorinated polymers. But also fluoropolymers have been taken into account in order to gather information regarding the total share of both, polymeric and non-polymeric PFASs. Since e.g. PFOA has been used for the manufacturing of PTFE, this source is of interest as well.

#### 3.3.1 Historical production volumes and use of PFOS

Paul et al. (2009) gave the first estimation of the global worldwide production of the PFOS precursor perfluorooctane sulfonyl fluoride (POSF). The total historical worldwide production of POSF between 1970 and 2002 was estimated to be 96,000 t. With a market share of about 78% of all POSF, the company 3M was the biggest producer then. Since cessation of POSF production by 3M in 2002 a reduction in some compartments has been observed (Paul et al., 2009). Due to the number of allowed exemptions in the Annex B of the Stockholm convention, there has also been an increasing production of POSF taking place in China.

Before 2004, the total Chinese production was less than 50 t per year, but China's annual output has grown due to the increase of PFOS application fields and demands overseas. According to 2006 statistics, 15 Chinese enterprises have been producing more than 200 t per year of POSF, about 100 t per year of which were exported to the EU, Brazil, and Japan (MEP, 2008, Lim et al., 2010). Due to its status as a regulated persistent organic pollutant (Wang et al., 2009), PFOS was included into the list of target analytes (Table 1). However, it is not known to what extent POSF based chemistry is used in textile and impregnating agents

### 3.3.2 Production volumes of PFCAs with focus on PFOA

The Organisation for Economic Co-operation and Development (OECD) surveys the yearly use and production of PFASs. The survey in 2009 was asking for information on 73 non-polymeric PFASs including PFCAs, FTOHs and perfluoroalkane sulfonamides (OECD, 2011). Worldwide 27 manufacturing companies producing PFASs and/or products containing PFASs were identified. From these a third (9 companies), producing in 18 sites in 7 countries responded to the survey.

- The concentrations of residual PFASs in the produced products ranged from about 0.1 up to 80,000 mg/kg.
- The total amount of non-polymeric PFASs was about 45 t with less than 3.3% (1.5 t) PFOA as unreacted residual present in products. Other related substances, including the 8:2- FTOH, amounted to approx. 50% (less than 22 t) in the products.
- From the survey response, the most commonly reported use of products containing PFCAs appears to be in the production of water/oil repellent products.

Since the results only represent a third of the manufacturing companies and do not reflect a distinct percentage of worldwide market, the value of these data is quite limited.

Prevedouros et al. (2006) estimated the global production of PFOA and its ammonium salt (APFO) between 1951 and 2004 to be 3,600-5,700 t (Table 2). Most of the APFO produced is estimated to have been used for the manufacturing process for fluoropolymers (Table 2). According to Environment Canada, there is no production of PFOA and its salts in Canada. For 2004 the imported PFOA was in the range of 0.1 to 100 t (Environment Canada, 2012). The OECD (2007b) estimated a production of APFO during 1995-2002 of 200-300 t per year.



Table 2. Global historical PFCA Production and Emissions Summary (modified from Prevedouros et al., 2006).

Environmental input source	Historical time period (years)	Estimated total global historical PFCA emissions (t)	Estimated total global production (t)
<b>PFOA / APFO manufacture</b>	1951-2004	400-700	<b>3,600-5,700</b>
Industrial and consumer uses			
Fluoropolymer manufacture (APFO)	1951-2004	<b>2,000-4,000</b>	
Fluoropolymer dispersion processing (APFO)	1951-2004	200-300	
Aqueous fire fighting foams (AFFF)	1965-1974	50-100	
Consumer and industrial products	1960-2000	<b>40-200</b>	
<b>Fluorotelomer-based products</b>			
PFCA residual impurities	1974-2004	0.3-30	
Fluorotelomer-based precursor degradation	1974-2004	6-130	
Fluorotelomer-based AFFF	1975-2004	<1	

In 2005 four main producers of APFO were known: Miteni (Italy), DuPont (USA), Daikin (Japan) and one Chinese producer (KEMI, 2006).

A study of the European Commission (2010) gave estimations on the market volume of production and import of PFOA and APFO in the EU-27 member states. Based upon the data retrieved from Norway, Denmark and Sweden during the years 2006-2008, 50-100 t per year PFOA and APFO are estimated to be produced and aswell used in EU-27. The tonnage of imports of PFOA and APFO from outside the member states are estimated to be below 5 t per year for direct sources and below 10 t per year for imported consumer products.

However, it is mentioned in the report that these figures should be used with much caution because of many uncertainties mentioned.

### 3.3.3 Production volumes of FTOHs

Recent estimations for global annual production rates of FTOHs are in the range between 6,000 t and 12,000 t (OECD 2007b; Schulze and Norin, 2006; Wallington et al., 2006). Schulze and Norin (2006) also estimated that about 50% of the production (5,000 t) goes to the impregnation of textile consumer products, e.g. in all-weather clothing, carpets and upholstery.

### 3.3.4 Production volumes of fluoropolymers

The Chemical Economics Handbook (CEH) Marketing Research Report 2002 located 33 fluoropolymers manufacturing sites worldwide in North America (8), Japan (7), China (7), Europe (7), Russia (2), and India (1) with a total fluoropolymer manufacturing capacity of 144,000 t per year. The main shares of fluoropolymers are PTFE, PVDF (polyvinylidene fluoride), FEP (perfluorethylen-propylen), PFA (PTFE-perfluoralkoxy-copolymer) and ECTFE (ethylene-chlorotrifluorethylen).

The only Russian producer of specialized fluoropolymers, HaloPolymer's enterprises, produced in the year 2010 over 7,000 t of fluoropolymers. According to the companies homepage this is a share of about 9% of the world market of a total of approx. 80,000 t (Halopolymer JSC, 2012).

The total fluoropolymer import volumes into Switzerland in 2007 were estimated to be around 2,000 t dry weight (d.w.), with PTFE (approx. 20–30%) and PVDF (approx. 30–45%) making up the majority of the import volumes (FOEN, 2009). The total amount of PFOA as residuals in



fluoropolymers imported to Switzerland was estimated to be approximately 2-10 kg per year, which is equal to 1-5 ppm dry weight.

Based on the given data of 80,000 to 144,000 t of total synthesized fluoropolymers per year, 1-5 ppm PFOA would result in an amount between 130-650 kg per year. However, it is not known from these global estimations, how much is used for DWR jacket production.

### 3.3.5 Production volumes of side-chain fluorinated polymers

To the best of authors' knowledge, exact figures regarding the worldwide production rates of side-chain fluorinated polymers have not been published so far. Thus, only rough estimations based on intermediates needed for their production can be done.

Fluoroacrylate is described as crucial component as it is responsible for oil repellency as well as for water repellency. If necessary, fluorinated urethane structures can be used which produce additional effects such as oil repellency (Lacasse and Baumann, 2004). As active components in fluorotelomer-based acrylate polymers, copolymers with 8:2-fluorotelomer acrylate (8:2 FTAc) and 8:2-fluorotelomer methacrylate (8:2 FTMAc) are described. These are synthesized by various chemical companies, such as e.g. Taiwanfluoro (Taiwanfluoro, 2013); on their company homepage they give the following information regarding the produced PFASs:

“Development and production of perfluoroalkyl iodide, perfluoroalkyl ethyl iodide, perfluoroalkyl ethanol, perfluoroalkyl vinyl and perfluoroalkyl ethyl acrylate and other products. These can be transformed to the corresponding alcohol, thiol, and sulfonyl chloride such as various fluorine-containing intermediates for further synthesis of various fluorine-containing surfactants, fluorine-containing finishing agents and other fluorine-containing fine chemicals. Such fluorinated products with high thermal stability, high chemical stability and excellent performance with its made of fluorinated finishing agent with conventional textile finishing agent incomparable characteristics, through their treatment of textiles with a variety of excellent performance, and thus much attention and welcome from domestic and foreign markets, to become the mainstream of today's textile finishing”. The purity and homologue constitution of the marketed PFAs are given on the company's website (Taiwanfluoro, 2013), as for example

Perfluoroalkylethyl acrylate:  $C_2F_5(CF_2CF_2)_n C_2H_4OCOCH=CH_2$ ;  $n=2-5$

$C_6F_{13}C_2H_4OCOCH=CH_2$  : 32 to 38%

$C_8F_{17}C_2H_4OCOCH=CH_2$  : 30 to 35%

$C_{10}F_{21}C_2H_4OCOCH=CH_2$  : 20 to 26%

$C_{12}F_{25}C_2H_4OCOCH=CH_2$  : 6 to 8%

Russel et al. (2008) analyzed an aqueous dispersion of a fluoroacrylate polymer, used as commercial stain and soil repellent for textiles, upon PFASs. PFOA, 8:2-FTOH and 10:2-FTOH were detected at concentration of 10, 1,200 and 650 ppm wet weight.

Eschauzier et al. (2012) investigated two different side-chain fluorinated polymers concerning non-polymeric PFASs intermediates, which showed different ratios depending on the product and producer. From the investigated PFASs, one side-chain fluorinated polymer contained mainly 6:2-FTOH (90%) whereas the other mainly 8:2- and 10:2-FTOH (approx. 45% each) could

be detected. The concentrations were between 1,000 and 10,000 ppm wet weight equal to 0.1 - 1%.

According to the EPA-Stewardship-Program of fluorchemical producers, a PFOA-reduction of 100% is envisaged until the year 2015 (compared to the year 2000) (USEPA 2013). Several producers of outdoor jackets have also announced this ambiguous goal in the meantime on their individual company homepages..

An estimation regarding the global production of side-chain fluorinated polymers was done. For this calculation it was assumed, that the share of reacted FTOHs on the MW of fluorinated polymers is roughly 2/3. This assumption is based on the presumed structures as given in Figure 3, as well as the information of Schröder (2009) and Fischer et al. (2006), that the typical fluorine content of the active polymer is estimated in the range between 20-50%. Thus, a usage of the assumed 10,000 t FTOHs (see chapter 3.3.3) would result in a global production rate of 15,000 t side-chain fluorinated polymers. Based on this assumption, the amount of side-chain fluorinated polymers produced would be roughly 10% of the worldwide production of fluoropolymers stated by Ring et al. (2002).

Schröder (2009) estimated an application of approx. 1,000 t per year of side-chain fluorinated polymers in the textile industry in Germany.

Considering a share of 0.1 to 1% (see above) residual unreacted FTOHs within the finished product of side-chain fluorinated polymers, this would result in 15 to 150 t of FTOHs, which could be globally released into the environment. This assumption is roughly in line with the estimated global release of FTOHs done by Yarwood et al. (2007).

Since according to Schulze and Norin (2006) 50% of the fluorotelomer-based polymers are used for textile treatment, a contribution to the global FTOHs release stemming from textiles would be in the range of 7.5 to 75 t. Schröder (2009) estimated a FTOH release from textiles into wastewater of approx. 50 kg per year.

However, all these estimations are only valid under the assumption that the polymeric PFASs are persistent and do not degrade to e.g. short-chain PFASs ( Russell et al. , 2008; Washington et al. 2009).

In summary, the uncertainties related to the unknown production figures of polymeric and non-polymeric PFASs also leads to exposure calculations, which have to be treated with caution.

### 3.4 Trading and consumption of PFASs with respect to DWR textiles

There are regular trade movements of mixtures containing fluorinated chemicals from and to Germany, which are regularly monitored by the German Statistisches Bundesamt. However, it cannot be differentiated by the type of chemicals and it cannot be distinguished between technical mixtures used for textiles or other applications. For example in the year 2010, an import of approximately 7,000 t of mixtures containing fluorinated chemicals faces an export of approximately 1,500 t (see Table 35 in supplement information).

Textile finishing products however, are both, produced in and exported from Germany and imported to Germany to a great extent. For example, 14,600 t with a value of 21 million euro were exported to Italy and equally imported with 2,750 t and a value of 3.8 Million euro. A trade surplus (a surplus in the balance of trade which occurs when the value of a country's exports exceeds that of its imports) was within the trade with Italy, Belgium, Turkey,

Bangladesh, Republic of China, Pakistan, India, Indonesia, Thailand and Brazil (see Table 36 in supplement information) reflecting the main producing sites of the textile industry. The dimension of export is around 110,000 t. A trade deficit resulted within the trade with France, Czech Republic and Japan.

In 2009, the China Dyeing and Printing Association reported that approximately 10,400 t of fluorine-containing textile finishing agents are used each year in China, from which about 10,000 tons were imported for the treatment of high-quality clothing (China Dyeing and Printing Association, 2009).

According to FOEN, 2009, it has been estimated that 3.3% (1.5 billion meters of a total 50 billion meters) of dyed and finished textiles have been treated with fluorinated chemicals. Most likely these agents are fluorotelomer-based polymers including PFASs as impurities.

The consumption of PFOS, PFOA and selected precursors has been estimated for the year 2007 in the Swiss textile industry and compared with the historical use (Table 3). Whereas the use of PFOS, PFOA, N-MeFOSE and N-EtFOSE has been tremendously reduced and can nowadays be considered as almost negligible, the use of FTOHs (8:2 and 10:2) seems to be constant with a best guess of 0.2 and 0.1 t per year (FOEN, 2009).

Taking a similar consumer behavior and the amount of inhabitants (8 Mio.) into consideration, a factor of 10 between Germany and Switzerland would lead to the following assumptions regarding the maximum use of PFASs for the German textile industry: PFOA: 0.01 t per year; 8:2- and 10:2- FTOHs 3 t per year and 1.5 t per year, respectively.

Table 3. Estimated consumption of PFOS, PFOA and selected precursors in the Swiss textile industry (FOEN, 2009).

Substance	Use in 2007 (kg/year)		Historical use (kg/year)	
	Best guess	Range	Best guess	Range
PFOS	0	-	2	0.1-8
PFOA	1	0.1-10	10	1-100
N-MeFOSE	0	-	30	10-60
N-EtFOSE	0	-	0.2	0.1-1
8:2-FTOH	200	130-300	200	130-300
10:2-FTOH	100	70-150	100	70-150

A search conducted in the Danish Product Register in 2007 regarding the use of PFASs in textile treatment and cleaning only gave sparse and not sufficient information (Jensen and Paulsen, 2008). The use areas polish and care products, impregnating agents, cleaning agents and surface active substances accounted only for about 0.5 t PFASs from a total of 16.5 t including paint, glue etc.. The Danish Product Register however does not register all products containing fluorinated compounds on the Danish market, and the registered amounts do not give an adequate picture of the total sales in Denmark (Jensen and Paulsen, 2008).

According to Jensen and Poulsen (2008), about 0.4 t PFASs (d.w.) have been used for impregnation of textiles (excluding carpets) in Denmark.

The trade of impregnated clothing in Denmark showed, for example, that in the year 2006 approx. 3,000 t were imported, whereas 1,000 t were exported (Jensen and Paulsen, 2008). It was not possible to identify the amount of PFASs containing repellents used for the finishing process of the clothes. Imported finished products such as raincoats containing PFASs are not registered in the Product Register (Jensen and Paulsen, 2008). There is also no registration of

PFOA deriving as residues in textile finishing products, which is estimated in the range of 0.1 to 1% of the total PFASs content (Jensen and Paulsen, 2008). Based on these figures, Jensen and Paulsen (2008) estimated an annual consumption between 14 t and more than 38 t of PFASs in consumer products in Denmark. Regarding the uncertainties described above, these data cannot be extrapolated to the European level of imported PFASs related to outdoor jackets.

The textile manufacturing industry in Sweden is small and in many cases specialized in more expensive niche products, which are still profitable to be produced in Sweden, e.g. multifunctional textiles treated with PFASs (KEMI, 2006). KEMI also states that the largest quantities (approximately 75%) of PFASs imported to Sweden in chemical products are from the textile industry (KEMI, 2006). FTOHs are the compounds most widely used in products from the textile industry, e.g. as impregnating agents and for water-resistant and dirt-resistant textiles and mats. According to trade experts, approximately 10-20% of all khaki trousers are treated with FTOHs to make them dirt repellent (KEMI, 2006).

Additionally PFASs related substances, with chain lengths from four to eight, are also used in impregnating agents for textiles (KEMI, 2006).

In the product register of the Swedish Chemical Agency, containing both, manufactured and imported goods, 24 t of PFASs (e.g. PFASs, PFCAs and related substances which could potentially degrade to PFCAs, above all FTOHs) have been listed in 2004 (KEMI, 2006). Not included are imports of finished products containing PFASs, such as textiles. It is assumed, that these products are accountable for the main import of PFASs to Sweden.

This assumption is confirmed by Schulze and Norin, 2006, who state that all PFASs being sold in the Nordic countries are imported, either in form of chemical/technical products or as components of solid processed products.

In the present chapter we summarized published as well as own researched data dealing with trading and production of PFASs related to textiles. Thereby the following obstacles have been faced:

- No harmonized terminology of the individual PFASs. Quite often it was not possible to distinguish for example between non-polymeric PFASs and fluorinated polymers.
- Different product groups being listed in the different governmental registers.
- No differentiation between treated and untreated textiles.
- Non accessible or restricted information from producers.

From the sparse information being given, we tried to evaluate the so far published analytical data. Additionally, several extrapolations and assumptions were done by the authors in order to obtain some figures needed for the exposure analysis.

In summary, based on the retrieved data in this report, it seems that PFASs, both polymeric and non-polymeric, being nowadays relevant as textile repellent chemicals are mainly based on fluorotelomer derivatives. Vice versa, fluorochemicals based on fluorinated sulfonamide derivatives seem to play a minor role.

Non-polymeric PFASs such as e.g. PFOA or PFOS are not used within the textile finishing process. Instead solely polymeric PFASs such as fluoropolymers and side-chain fluorinated

polymers with a MW above 20,000 Da are used (Fischer et al., 2006). However, PFOA and FTOHs are possible impurities of the polymeric PFASs in use (Schröder, 2009).

### 3.5 Review of PFASs concentrations in textiles

Prior to this study only a few analyses of outdoor textiles on PFASs have been carried out. The outcomes of these investigations are discussed below. The often cited study of Berger and Herzke, where 17 textile garments including 9 outdoor jackets of different brands were investigated, is already from the year 2006 (Berger and Herzke, 2006, see Table 4). Thereby 30 different compounds were analyzed, amongst them PFOA and 8:2-FTOH which could be detected in 16 of the 17 products (detailed data can be partially retrieved from Schulze and Norin, 2006). Both, the extractable amount per area product ( $\mu\text{g}/\text{m}^2$ ) and per gram product (ng/g) were reported. The extractable content of FTOHs ranged between <27 and 10,700  $\mu\text{g}/\text{m}^2$  of textile, the extractable content of PFCAs between <5 and 428  $\mu\text{g}/\text{m}^2$  of textile and an extractable content of PFSAAs was between <5 and 30  $\mu\text{g}/\text{m}^2$  of textile.

Table 4. Extractable PFASs from different textile samples summarized in groups ( $\mu\text{g}/\text{m}^2$  textile).

Type	Manufacturer	Sum FTSS/FTCAs	Sum FOSA/FOSE	Sum FTOHs	PFOS	Sum PFSAAs	PFOA	Sum PFCAs
Alpine trousers, kids	Kmk by Kilmanock	<LOD	<LOD	<LOD		0.06		6.84
Overall, kids	Colour Kids CK-Sport Extreme	<LOD	0.06	98		<LOD		2.97
Rain & outdoor jacket	Marmot	2.72	22.8	10,700		30.5		34.9
PTFE table-cloth	Sandvika Seiersborg	5.56	0.03	285		0.04		170
Alpine jacket	Head	0.33	<LOD	42		0.03		10.8
Sport jacket	Ultimo	0.09	<LOD	87		<LOD		18.9
Trousers kids	Reima	0.38	0.03	8.43		0.17		3.41
Overall	Hennes & Mauritz	<LOD	0.04	207		0.07		2.71
Waterproof jacket	Stromberg Veiviser	<LOD	1.08	155		0.07		6.97
Safari-Jacket	Stromberg	0.06	0.36	33		0.06		17.6
1000 textile	Fjäll Räven	0.97	0.74	168		0.26		94.7
Cotton textile	Bergans	1.54	107	41	20.2	23.3	127	428
Synthetic textile	Bergans	<LOD	5.73	74	0.07	0.12	23.2	48.5
Jacket	Polar O. Pyret	1.87	1.43	91	<LOD	0.02	4.8	16.4
Jacket	Peak Performance	1.92	14.1	385	0.16	0.28	24.6	55.9
Sailing jacket	Helly Hansen	3.87	6.10	1,000	0.20	0.67	20.4	53.3
Rain jacket	Stadium	<LOD	4.30	27	0.24	0.44	0.80	1.89

Berger und Herzke (2006) : 10:2 FT olefine values in general below LOD; four values between 0.13 and 1.1  $\mu\text{g}/\text{m}^2$ ; analyses were performed in the laboratories of the Norwegian Institute for Air Research (NILU); the analytical method being used as well as quality control data are given in the analytical report of Schulze and Norin, 2006.

In general the few, so far published results are difficult to be compared with respect to different analytical methods as well as different products being investigated. With regard to the individual analytical methods, validation including for example the extraction method as well recovery rates of the individual analytes could not be retrieved. With the criteria being addressed within the present study, a more general and updated database was aimed to achieve (chapter 4).



### 3.6 Environmental emissions of PFASs related to textiles

Regarding the environmental emission of PFASs stemming from the use and disposal of outdoor jackets to the authors' best knowledge no data have been published so far. Various non-peer-reviewed documents discuss the environmental impact of the storage of polymeric PFASs or their incineration. However, during the literature research conducted for this report the authors came to the conclusion that data from systematic studies are not present so far.

Only few data are available regarding the release of non-polymeric PFASs into the environment. The most recent and complete study from the OECD (2011) indicates, that only very small quantities of PFASs, e.g. PFOA, were released to air or water systems compared to incineration, recycle and recover. Release to landfill, underground injection and on-site and off-site transfer could not be provided due to confidential business information (see supplement information, Table 38).

Storage of PFASs in local landfills might sooner or later lead to their release into the environment via leachates (Busch et al., 2010).

The PFASs concentrations analyzed in outdoor jackets alone do not give substantial information regarding the overall exposure since only such PFASs can be quantified which are extractable from the fabric.

According to Figure 2, one has to perform a more holistic approach, covering the entire life cycle of such a textile. Thus the obtained analytical results, even if validated regarding their trueness, need to be critically evaluated regarding exposure. For example the amount of side-chain fluorinated PFASs including the unreacted impurities being introduced onto the fiber during the finishing process should be known. However, immediately after the pad-dry-cure-process, the PFASs-content might change due to for example losses of volatile FTOHs. Thus the time span between production and analysis, as well as a number of different factors will at the end influence the amount of detectable PFASs. Another factor will be the definition of PFASs-free, as this will depend on the analytical methods used. Additionally the amount of detectable PFASs might be influenced by cross-contamination from e.g. the machines used for the finishing process or the packaging and transport.

Following the purchase and first uses of the DWR textile, a jacket might not be washed within the first six months. This consumer behavior depends on the quality of the material, the frequency of use and the initial degree of water repellency. Starting already with the washing, the repellency effect might diminish quite rapidly. This however will depend on the amount of repellent used as well as the applied finishing process in general (personal communication DWR jacket producer).

A further impregnation will enhance again the water repellency, but the initial level most likely will not be reached again. Additionally, repellents based on a perfluorinated alkyl chain shorter than C<sub>8</sub> will be less effective. Thus a higher yield of PFASs < C<sub>8</sub> in the marketed sprays and washing powder is anticipated (personal communication repellent producer).

Following this literature search, one might expect that washing of outdoor jackets might contribute to the contamination of municipal waste water with water soluble PFASs. However, according to the KEMI report from 2006 (KEMI, 2006) it has not been known, how the PFASs-concentrations are affected through washing of commercially treated textiles. This should be one task of the present study.

At least air exposition has been studied briefly in 2006 by the Norwegian Institute for Air Research (NILU) (KEMI, 2006). It was assumed that many residuals from fluorotelomer based polymers might be released into the air. Analyses of Norwegian indoor air gave PFASs concentrations, which were approximately 100 times higher, compared to outdoor air. It was assumed that volatile FTOHs evaporation from both, clothes and furniture, have been the main contributors (KEMI, 2006).

Since this report, several studies have shown the presence of FTOHs in indoor and outdoor air (Table 5; Langer et al., 2010; Müller et al., 2012; Jahnke et al., 2007b; Barber et al., 2007; Shoeib et al., 2011).

Langer et al. (2010) took air samples with a passive sampler for a period of 14 days in two shops selling outdoor clothing. 8:2-FTOH was observed in highest concentrations; 196-209 ng/m<sup>3</sup> against 48-54 ng/m<sup>3</sup> for 10:2-FTOH. These concentrations are up to 50-fold higher than other values reported for indoor air (Table 5).

Another study measured indoor air concentrations in an office with and without a paraglider (Jahnke et al., 2007b). The paraglider was treated with PFASs, which caused highly elevated concentrations of FTOHs in the indoor air. 10:2-FTOH was the dominant compound, followed by 8:2-FTOH in concentrations of 58 ng/m<sup>3</sup> and 34 ng/m<sup>3</sup>, respectively. In the office without the paraglider, concentrations were up to 81-fold lower than in the office containing the paraglider.

A study by Shoeib et al. (2011) measured indoor air concentrations in a total of 59 homes in Canada. The indoor profile was dominated by 8:2-FTOH followed by 6:2-FTOH and 10:2-FTOH with sum FTOH concentrations ranging from 0.89 ng/m<sup>3</sup> up to 470 ng/m<sup>3</sup>. These compounds were positively correlated, suggesting that they originated from the same source. Outdoor air concentrations were approximately 17 times lower compared to indoor values, with 8:2-FTOH as the dominating compound. Barber et al. (2007) measured a range of environmental air samples. Neutral PFASs were detected in all outdoor air samples with 8:2-FTOH as the dominant analyte. Concentrations were low, ranging from 0.011 ng/m<sup>3</sup> to 0.243 ng/m<sup>3</sup> for 8:2-FTOH. Samples taken from indoor air showed elevated FTOH concentrations ranging from 12 ng/m<sup>3</sup> up to 369 ng/m<sup>3</sup>.

In most of the samples taken 8:2-FTOH was the dominating compound, except for the office in which a paraglider was stored (Table 5; Müller et al., 2012; Jahnke et al., 2007a).



Table 5. Literature PFASs concentrations in outdoor and indoor air reported in the literature. All concentrations are given in ng/m<sup>3</sup>.

Literature	6:2-FTOH	8:2-FTOH	10:2-FTOH	Sum FTOHs	Source
Müller et al. (2012)	0.06	0.70	0.19	0.95	Outdoor urban air
Jahnke et al. (2007b)	0.07	0.12	0.04	0.22	Outdoor urban air
Barber et al.(2007)	0.19	0.24	0.07	0.49	Outdoor urban air
Barber et al. (2007)	2.99	3.42	3.56	11.1	Indoor air
Shoeib et al.(2011)	2.44	3.79	1.42	7.74	Indoor air
Schlummer et al. (2013)	0.15-9.91	0.25-9.91	0.11-5.14	0.51-29.3	Indoor air
Jahnke et al.(2007b)	0.25	0.42	1.66	2.33	Office air (20m <sup>3</sup> )
Jahnke et al. (2007b)	1.09	33.9	57.7	92.7	Office air (20m <sup>3</sup> ) and paraglider
Fraser et al. (2012)	<LOD-11	0.24-70.6	0.14-12.6	0.38-94.2	Office air
Langer et al. (2010)	13-37	79-209	28-54	130-307	Outdoor clothing store
van Driezum et al. (2014 in prep.)	<LOD	16.7-20.7	7.79-9.42	26.2-28.5	Outdoor clothing store
van Driezum et al. (2014 in prep.)	<LOD	1.9	1.2	3.1	Indoor laboratory air

From this data, it can be seen that indoor air concentrations of FTOHs can be up to 17-fold higher than outdoor air concentrations. In order to quantify and rate this kind of exposure, within the present study the contributions of outdoor jackets as potential source of volatile PFASs into the air were experimentally evaluated for the first time.

In order to fulfill the request regarding the different exposure studies, besides the query on the amount of produced and imported PFASs, the average PFASs concentration in the jacket additionally the necessity of reliable figures covering the amount of produced DWR jackets are needed. This is addressed in the following chapter.

### 3.7 Estimation of the quantity of outdoor jackets imported to Germany

Europe and with it Germany used to be a production site for high quality textiles for several decades. With the globalization and the possibility of low cost production within the developing countries, a tremendous shift, also in the textile production has been recognized. With the following chapter the authors tried to close some gaps by mainly performing retailer requests.

The turnover of the textile and clothing sector in the EU in 2009 amounted to roughly 167 billion euro, down from 198 billion euro in 2008 (European Commission, 2011). Within this report it is stated, that even up to date the finishing operations remain within the EU. The processing of raw materials and production of garments are being outsourced, whereas the production becomes increasingly global. In the EU, the biggest producers are the five most

populated countries, i.e. Italy, Germany, France, Spain and the UK, accounting for about 75% of the EU-27 production of textiles and clothing.

Following personal communications to several representatives of the DWR textile producing companies regarding their garment production, the followings statements can be considered as being generally valid:

- Production of highest quality garments is mostly done in Asian countries, especially in the Far East, like China and Vietnam. Manufacturing in Germany, respectively the EU, is negligible due to higher manufacturing costs within these countries and production sites in the Far East are superior to most European sites, being too old fashioned. Long term contracts with production sites in the Far East ensure a high knowledge, a good training for employees, modern facilities and a proper work environment.
- Only minor productions are done in the so called high risk countries, for example Bangladesh, Myanmar, Peoples Republic of North Korea or Colombia since these countries do not work according to the demanded innovative European techniques.

Some minor DWR production sites, which still can be found in Europe, are for example the company Delcotex, producing the “Cordura® fabric” in Bielefeld, Germany; fibers are treated with fluorocarbons (INVISTA, 2013) or the company FOV Fabrics AB, Sweden, which produces high tech fabrics with PU membranes or PU coating for apparel (FOV Fabrics AB, 2014).

For Germany it has been possible to obtain import and export data of several goods from the German Federal Statistical Office (2014). From these data given, the authors made inventory tables by putting the most relevant information within a few tables. Examples are given below and/or listed in the supplement information section 12.2 under “Information from “Statistisches Bundesamt””.

For Germany the trade deficit in the years 2009 to 2011 of anoraks and windbreakers was quite stable in the range of 80 Million pieces +/- 10% with an average weight of one piece of about 1.5 kg (Table 6). However, within the inventory given by the Statistisches Bundesamt, Germany, it is not known, whether the jackets contain PFASs.

Table 6. Compilation of anoraks and windbreaker; given are number of pieces and weight; data obtained from the Statistisches Bundesamt, Germany for the years 2009, 2010 and 2011.

anoraks including windbreaker made of cotton, chemical fibers and garment	Export		Import		Trade deficit
	pieces (Mio)	weight (Mio kg)	pieces (Mio)	weight (Mio kg)	pieces (Mio)
Men	10.157	8.449	32.495	28.662	22.338
women	29.408	18.369	82.971	55.769	53.564
<b>Sum Year 2009</b>	<b>39.565</b>	<b>26.818</b>	<b>115.466</b>	<b>84.431</b>	<b>75.902</b>
men	12.634	10.539	35.506	29.632	22.872
women	33.805	21.095	83.845	53.910	50.040
<b>Sum Year 2010</b>	<b>46.439</b>	<b>31.634</b>	<b>119.351</b>	<b>83.543</b>	<b>72.912</b>
men	12.421	9.986	41.975	33.565	29.554
women	33.934	20.157	92.160	57.547	58.226
<b>Sum Year 2011</b>	<b>46.355</b>	<b>30.144</b>	<b>134.135</b>	<b>91.113</b>	<b>87.780</b>

(Statistisches Bundesamt, 2014) ; 2011, 2012; Stand: 24.11.2011 / 13:40:27 und Stand: 06.03.2012 / 07:18:40; The total amount consists of the following products: WA61012090 – jackets, amongst others windjackets, cotton, menswear, WA61022090 – jackets, amongst others wind jackets, cotton, womanswear, WA61013090 – jackets and others, of chemical fibers, menswear, WA61023090 – jackets and others, of chemical fibers, womenswear, WA61019080 – jackets and others of garment, menswear, WA61029090 – jackets and others of garment, womenswear, WA62019200 – jackets, windjackets, cotton, menswear, WA62029200 – jackets, windjackets, womenswear, WA62019300 – jackets, windjackets and others, chemical fibers, menswear, WA62029300 – jackets, windjackets and others, chemical fibers, womenswear, WA62019900 – jackets, windjackets and others, garment, menswear, WA62029900 – jackets, windjackets and others, garment, womenswear.

In Table 7, the German trade of working gear for years 2009 to 2011 is given in t. Comparing the import in weight of working gear with the data given for anoraks and windbreakers (Table 6), the importet volume of working gear is ca. 30-fold lower than calculated for anaoraks and windbreaker.

Table 7. Compilation of trade working gear, men, for Germany given in t weight; data given from the Statistisches Bundesamt, Germany for the years 2009, 2010 and 2011.

Working gear, men	Export Weight	Import Weight	Trade deficit
	t	t	t
Sum Year 2009	627	2,562	1,935
Sum Year 2010	711	2,373	1,662
Sum Year 2011	633	2,881	2,248

(Statistisches Bundesamt, 2014); 2011, 2012; Stand: 24.11.2011 / 13:40:27 und Stand: 06.03.2012 / 07:18:40; The total amount consists of the following products: WA62113210 - workwear of cotton, for men; WA62113310 - workwear of chemical fibers, for men.

The production of outdoor clothing is a global process. There are several suppliers from a series of producing countries. For example, the company Patagonia, which is used quite often as a superior example for open access to information of production sites, produces in all the countries and locations listed in Table 39 in the supplement information.

Quite a few textile companies are specialized in the production of outdoor wear, ski wear, sportswear and casual wear. For example the company Lee Lin Apparel C. Ltd. manages in

Bangkok and Mae Sot, Thailand six factories with around 2,500 workers. According to their website, customers are mainly European brands such as Jack Wolfskin, Asics, Strellson, Brax, Joop, and Finkid. The capacity of Lee Lin is about two million pieces per year, including jackets (400,000), fleece (350,000), pants (400,000), tights (350,000), polo- and T- shirts (250,000 each) (Lee Lin Apparel, 2011).

Some of the outdoor branch market leaders, as for example The North Face, Wrangler, Timberland, Jansport, and others, belong to the umbrella brand VF. Resulting from this, a search regarding the origin of the materials that one company uses or how the clothing is manufactured is not possible at all. According to their homepage, VF is the world's largest apparel company with more than \$9 billion in annual revenues, over 30 dynamic lifestyle brands and over 52,000 associates working in locations across the globe. Their brands are sold in more than 150 countries through 47,000 retailers in all channels of distribution. Besides operating more than 1,000 retail stores many brands are directly sold to consumers over the Internet. Sourcing and manufacturing are managed through their Global Supply Chain organization, which oversees the production of 500 million items annually at more than 1,400 owned or sourced facilities in locations around the world (VFC, 2011).

Figure 4 shows the most important countries for the German textile market. It can be seen that already the import from China with a value above 8 billion euro is almost a factor three above the following main importers, such as Turkey and Bangladesh. Besides Italy, the Netherlands and Romania, the most important import countries are exclusively from Asia (GermanFashion Modeverband Deutschland e.V, 2011).

Figure 4. Most important import countries for the German textile market in 2011; import value given in 1,000 Euro

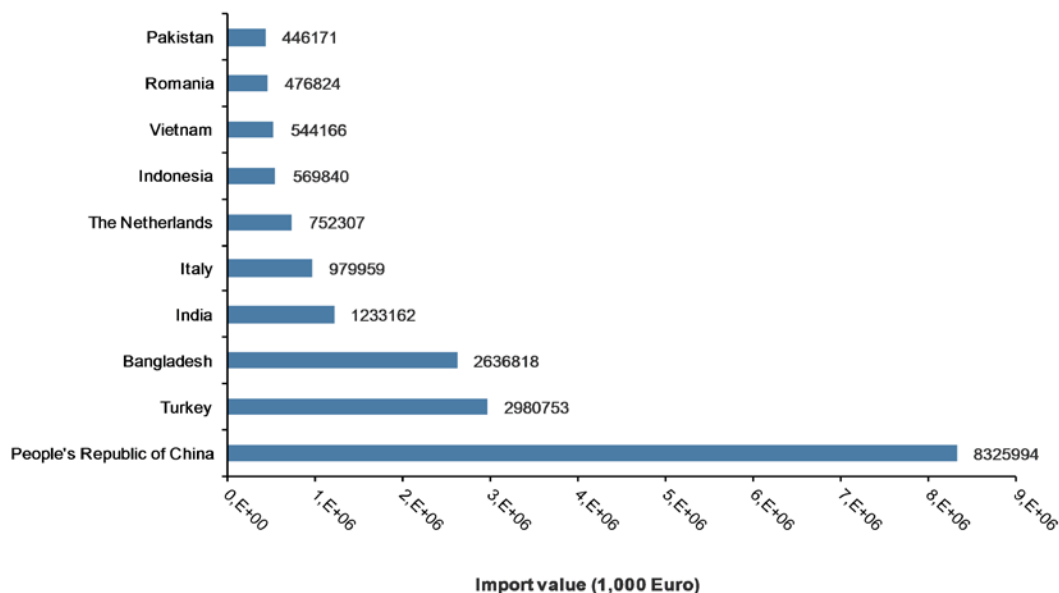

(GermanFashion Modeverband Deutschland e.V., 2011)

An estimation regarding the share of DWR textiles within the European market is difficult to be done. Besides the textile and clothing trade, already the non-textile-trade (see Table 8), with for example a share of 7.3 billion euros for the mail order business, is higher than the trade within the department stores and sport outfitters.

Table 8. Textile and clothes market in the “Non-Textile-Trade” in Germany from 2009-2010; (Turnover in million euro).

Non-Textile-Trade	Year 2009	Year 2010
Mail order business	7,300	7,255
Department stores	6,100	6,125
Food retailers	3,070	3,095
Different retail segments	2,110	2,215
Sports outfitters	1,300	1,405
Furnishings and equipment stores	1,130	1,120
Market trading	950	985
Do-it-yourself store	200	200

(BTE, 2012)

A sales inquiry of the German “Gesellschaft für Konsumgüterforschung (GfK)” among sports shops and sport departments of big department stores did not include sport clothing sold by discounters. The results of the GfK showed a sales volume of 4 billion euro in Germany in 2010. The biggest volume sold of approx. 1 billion euro was accounted for the outdoor branch. The entire market, including discounters and no-name brands, was estimated to be 7.5 billion euro in Germany. (Sport-Fachhandel, 2011a)

Also the product association European Outdoor Group (EOG) does several enquiries on the products and market. In 2010 the sales volume in the European outdoor market was 9.7 billion euro. Textiles accounted for 49% and shoes for 23%. With a sales volume of 2.3 billion euro, Germany remains to have the biggest outdoor market, followed by Great Britain, France, Scandinavia, and Switzerland. The German speaking part of Europe generated about 36% of all revenues in 19 countries. For textiles alone, Germany contributed 25% of the total sales volume of 4.8 billion euro (equal to 1.2 billion euro) (Sport-Fachhandel, 2011b).

The market leader in Europe is Jack Wolfskin, which had a sales raise of 22% to 251 million euro in 2010 (Zeit, 2010) and according to Figure 5, another raise in 2011 up to 355 million euro. In Figure 5, the turnover of the leading outdoor brands in 2011 is shown. The branch leader Columbia has already a turnover of more than 1.3 billion euro and thus a factor of almost 4 above the market leader in Europe (Figure 5).

Figure 5. Turnover of the leading outdoor-brands in the year 2011 (in millions euro)

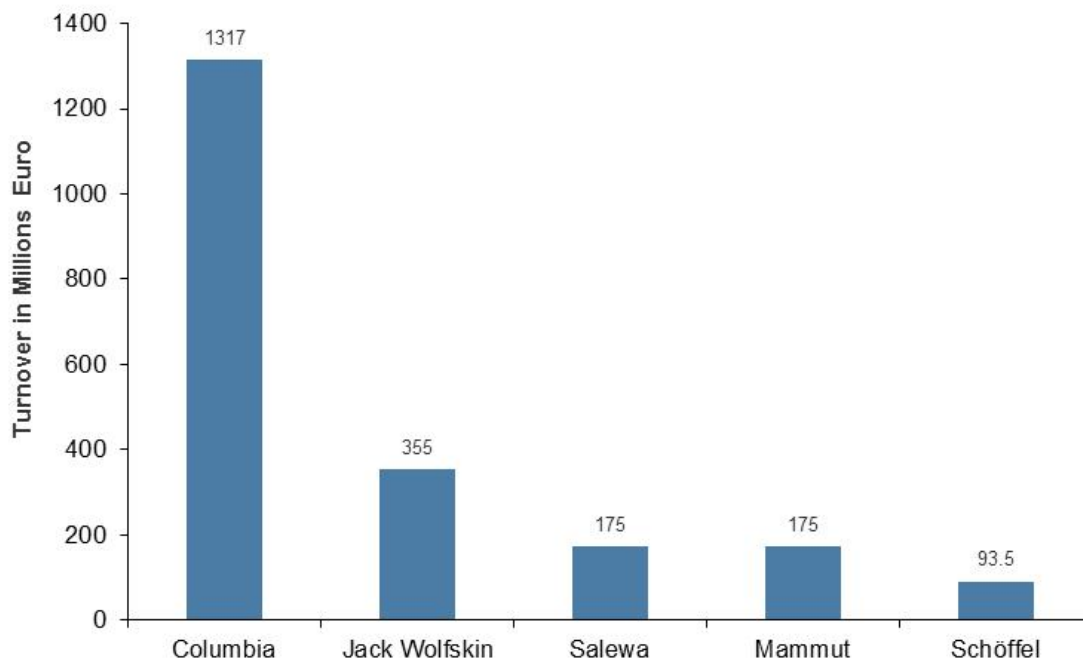

(Handelsblatt, 2011).

Enquiries at some randomly selected outdoor shops and manufacturers did not succeed in receiving statistically reliable sales numbers.

Online internet investigations made by the authors of this study in November 2011, gave information regarding the share of DWR jackets among the total number of outdoor jackets being presently available in four different stores including also online-stores. Additional information regarding the share of PTFE membranes in DWR jackets was supplied (Figure 6). From the given numbers of a total of 6,341 jackets, 780 (12.3%) were DWR jackets. From these DWR jackets 296 were based on PTFE technology.

Figure 6. Share of DWR jackets among the total number of outdoor jackets in stores including also online-stores in November 2011.

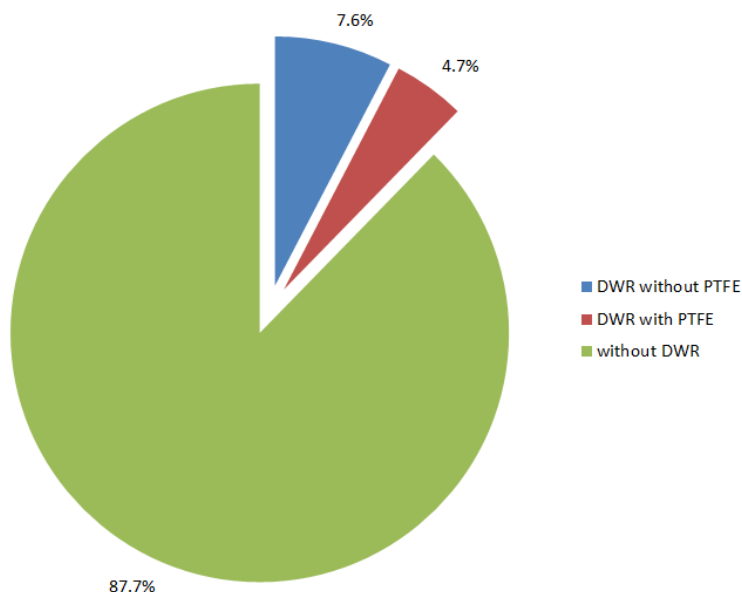

Media Control regularly analyses sales numbers of outdoor jackets in Germany. Since 2007, these calculations are based on average sales numbers. The service of Media Control is fee based; only a few data could be retrieved for free from the website of the VDS Sportfachhandel (VDS Sportfachhandel, 2014).

For example, a survey from the calendar week 37/2011 shows that in the group of the ten most jackets types sold, no PTFE membranes are present (Table 9). Thus the above number regarding the actual share of PTFE-based DWR jackets does not reflect the amount of jackets being sold.

The sold numbers support the data from the market analysis. Jack Wolfskin is one of the best-selling brands in Germany, followed by The North Face.

Table 9. Top 10 sales number in German sports shops exemplarily taken for the calendar weeks (cw) 23./37./39. in 2011, and 41. in 2010;

	Product	Company
<b>cw</b>	<b>37/2011</b>	
1	Evolution Triclimatic Jacket	The North Face
2	Evolution Triclimatic Jacket	The North Face
3	Softshell Hood	Campagnolo
4	Cold Valley	Jack Wolfskin
5	City SW	Salewa
6	Softshell Fix Hood	Campagnolo
7	Cold Valley	Jack Wolfskin
8	Softshell Hood	Campagnolo
9	Base Shell II	Schöffel
10	Aurora	Jack Wolfskin
<b>cw</b>	<b>29/2011</b>	
1	Vortex	Jack Wolfskin
2	Topaz	Jack Wolfskin
3	Topaz	Jack Wolfskin
4	Costana	Killtec
5	Black Range	Jack Wolfskin
6	Potent	The North Face



	Product	Company
7	Potent	The North Face
8	Resolve	The North Face
9	Espejo	Killtec
10	Vortex	Jack Wolfskin
cw	<b>23/2011</b>	
1	Topaz	Jack Wolfskin
2	Black Range	Jack Wolfskin
3	Potent	The North Face
4	Vortex	Jack Wolfskin
5	Highland	Jack Wolfskin
6	Muddy Pass	Jack Wolfskin
7	Base Shell	Schöffel
8	Electron Softshell	Jack Wolfskin
9	Positron	Jack Wolfskin
10	Assembly	Jack Wolfskin
cw	<b>41/2010</b>	
1	Iceland	Jack Wolfskin
2	Evolution Triclimate Jacket	The North Face
3	Iceland	Jack Wolfskin
4	Cold Valley	Jack Wolfskin
5	Icedancer	Jack Wolfskin
6	Serpetine Jacket	Jack Wolfskin
7	Evolution Triclimate Jacket	The North Face
8	Serpetine Jacket	Jack Wolfskin
9	Cold Valley	Jack Wolfskin
10	Genesis	Jack Wolfskin

(VDS Sportfachhandel, 2014).

It can be concluded that from the European outdoor market (approx. 10 billion euro in 2010), the market share of apparel is 52% and of DWR textiles about 22%. The sales by country were 24% for Germany in 2011. Based on these numbers a turnover of approx. 550 million euro for DWR textiles can be estimated for Germany in 2011 (EOG, 2012, Gröber, 2013). The share of outdoor jackets can only be assumed.

Unfortunately, the turnover and share of those DWR jackets which are produced by companies being not member of the European Outdoor Group (EOG) is not documented. Most likely, these companies produce and market the jackets in the price range between 10 euro and 100 euro.

From the 88 million jackets of the trade deficit into Germany in 2011 additional information required for a thorough balance calculation would be needed, which cannot be retrieved. The information deemed necessary should for example cover the share of PFASs treated and PFASs containing jackets.

### 3.8 Measures of the textile industry for sustainable purposes

#### 3.8.1 Recycling of DWR textiles

An individual return of used outdoor jackets into the sales store has been initiated some 20-30 years ago, but has not been adopted by the customer. Nowadays, there are no more such commitments (personal communication outdoor shop, Wiesbaden 12/2011).

However, to the authors' best knowledge, a recycling process of textiles being made of, or containing PFASs has never been successfully installed. Information of a manufacturer of outdoor gear regarding the recycling behavior of customers is as follows: "In general, especially outdoor jackets are worn out, whereas the life span on average is above 10 years, and then disposed in the household trash. Recycling is still negligible." Similar results upon surveys conducted in Scandinavian countries have been reported in KEMI, 2006.

However, in the meantime it seems that several fabrics, as e.g. the Sympatex® membrane could be recyclable similarly to PET bottles. Again, detailed information has not been made available until now.

More specific information retrieved during the authors' search conducted can be found in the supplement information (see chapter 12.6).

《蓝色标志标准是》针对纺织品、环境保护、消费者和雇员保护的最严格的法规

### 3.8.2 Voluntary control of PFASs related to outdoor jackets

Several standards, as for example the "Oeko-tex Standard 100" (Oeko Tex, 2014a) or the "Blue Sign Standard" (Blue Sign, 2013a) have been adopted by some of the key outdoor gear producing companies. The Blue Sign Standard is to the authors' knowledge the strictest textile standard for environmental protection and consumer and employee protection. Companies that work according to this standard have to monitor the environmentally relevant processes such as the production, the recycling, the chemical treatment, the working conditions etc. Also PFASs, such as PFCAs, PFASs, FTOHs and fluorotelomer(meth)acrylates are included in the chemicals list with a limited allowed concentration in the marketed products. However, even if for example for PFOA this value is limited to a concentration of 50 µg/kg, sum concentrations of potential precursors such as 8:2-FTOH and 6:2-FTOH are allowed to be in range up to 50 mg/kg (Bluesign, 2013b)

The accession to initiatives such as Fair Wear Foundation ([www.fairwear.org](http://www.fairwear.org)) can also be seen as a result of the debate on sustainability and the social responsibility in the manufacturing process. The Fair Wear Foundation is an independent verification initiative which works together with companies and manufacturers in order to improve the labor conditions for employees working in the textile industry. Around 70 companies represent 100 brands in seven different European countries. The production takes place in 15 different countries in Asia, Europe and Africa.

In the stores visited so far by the authors of this report during the study in the Rhine-Main region, the impregnating agents (both sprays and washing lotions) did not contain any PFASs according to the manufacturers' label. However, it might be possible that PFASs are still contained. Also it is very likely that impregnating agents containing PFASs are still in circulation at mailing order companies. Some manufacturers advertise with the production of more environmentally friendly impregnating agents, however, a detailed description of the ingredients has nowhere been mentioned, including the safety data sheets.

Fluorinated short chain sulfonates with four carbon atoms have been developed by the company 3M as an alternative to PFOS, among other compounds. These compounds are also extremely persistent, but less bioaccumulative or toxic (KEMI, 2006).

The same is true for short chain PFCAs with six and less perfluorinated carbons. Since the short chain PFASs are generally more polar, it is expected that the concentration detected in ground water will steadily increase with the anticipated growing production rate (Gellrich et al., 2012).

Much has been done to develop degradable fluorochemicals (Frömel and Knepper, 2010), however, a suitable material to be used in the textile industry has not been patented to the authors' best knowledge.

### **3.8.3 Assessment of potential PFASs emissions during the production of textiles into the atmosphere, waste water, surface water and soil in the EU production sites.**

Prevedouros et al. (2006) summarized through modeling the recent and the historical global use of PFASs, in the last 50 years, distinguishing between direct and indirect sources of PFASs. Typical direct sources are represented by the manufacturing of both, fluorochemicals and articles treated with fluorochemicals. Typical indirect sources are emissions from fluorochemical treated articles and disposed fluorochemical preparations.

The United States Environmental Protection Agency (EPA, USA) compiles a yearly inventory regarding the emissions and product content of PFOA, its precursors and higher homologues (USEPA, 2008).

Table 10 shows the product content and emission data of PFOA, precursors and higher homologues reported from 8 major non-US manufacturers in 2008.

The production of outdoor gear, including jackets, is very complex and difficult to tackle. In general production sites are all over the world, as shown exemplarily for the company Patagonia. Taking into consideration not only the finishing – mostly with side-chain fluorinated polymers – already the different textile materials are enormous.

Thus it seems not to be reasonable to differentiate between production processes occurring either in Germany or the other EU countries. Regarding the available literature, the situation in all described countries seems to be the same. The globally relevant processes regarding the fiber and garments as well as textile treatment has been reviewed. These processes mainly occur with Asian countries. It is highly likely, that during these finishing processes PFASs emissions into the environment will occur. However, even if there are a few production plants within Europe, this kind of point source seems to be of minor importance for Germany and the other EU countries.

During the evaluation of the PFASs-production, not only the emitted amount, but also the chemical constitution should be taken into consideration.

Understanding exposure pathways of PFASs via use of PFASs-containing products –risk estimation for man and environment

Table 10. Reported emissions and product content of PFOA, precursors, and higher homologues from non-US operations from 2008; data retrieved from USEPA (2008).

Company	Chemical Category	Emissions		Product Content		
		Release to all media from FP and Telomer Manufacturing (kg)	Kg of release / kg of product produced	Dispersions /ppm wet weight basis)	Other Fluoropolymers (ppm dry-weight basis)	Telomers (ppm dry-weight basis, unless stated otherwise)
Arkema	PFOA and higher Homologues	> 1,000 – 10,000	For FP Production: (> 0.1 – 1) kg/100kg	Not Applicable	> 70 - 150	Not Applicable
	Precursors	Not Applicable				
Asahi	PFOA, PFOA Salts and Higher Homologues	3,91	For FP Production: < 1 kg/100kg	5 – 2,900	18	Negligible compared to precursors
	Precursors	2,31	For Telomer Production: < 1 kg/100kg	Not Applicable	Not Applicable	Average 50% (range: 0-100%)
Ciba	PFOA	16 kg (total for emissions and product content)				
	Higher Homologues	14 kg (total for emissions and product content)				
	Precursors	545 kg (total for emissions and product content)				
Clariant	PFOA and PFOA Salts	1	For Telomer Production: 2.0 E-5 kg / 100 kg	None reported	None reported	2 kg
	Stromberg Veiviser	< 3	For Telomer Production: 6.0 E-5 kg / 100 kg	None reported	None reported	60 kg
Daikin	PFOA	< 2,500	None reported	< 100	< 120	< 5 kg
	Precursors and Higher Homologues	< 1,000	None reported	Not Applicable	Not Applicable	CBI
DuPont	PFOA and PFOA salts	1,410	None reported	120	0	21 kg
	Higher Homologues	None reported	None reported			None reported
	Precursors	None reported	None reported	None reported	None reported	3 kg
Dyneon/ 3M	PFOA, PFOA Salts and Higher Homologues	1,27	For FP Production: < 1 kg/100kg	8	Not Applicable	Not Applicable
	Precursors	Not Applicable				
Solvay Solexis	PFOA, PFOA Salts and Higher Homologues	Not Applicable				
	Precursors	Not Applicable				

### 3.9 Production of impregnating agents and their PFASs contents

As mentioned above, the water repellency of outdoor jackets will diminish in correlation with the amount of performed washing cycles. Thereby only the water repellency of the outer fabric is affected and can be regained by the proper use of impregnating agents. Thus, the use of such treatment agents might contribute to the PFASs burden related to such treated outdoor jackets.

According to Jensen and Poulsen (2008) as well as the author's investigations, the main brands on the market for impregnating agents are Kiwi, Granger, Nikwax, Boston and Imprenex. Some do not only produce as trademark, but also as store brand or own brand for different companies (personal information of a repellent producer).

Some of the PFASs based impregnating agents have been produced in Germany, e.g. in Ingolstadt, Bavaria. Other companies have production facilities e.g. in the Netherlands and the US. A company producing in East Sussex, Great Britain states that their impregnating agents always had been free of PFASs (Handel + Verkauf, 2013).

A company producing in Orangeburg, South Carolina (US) has products with permanent durable water repellency. These are either based on PFASs or on silicone technology and free of PFASs. However, the active ingredients remain unknown.

Some labels of the products are definitively misleading the user regarding the active compounds contained in the mixtures. A company producing in Germany and the Netherlands has a recently developed product line consisting of a "new generation of substances - C<sub>6</sub> fluorine agents". On the tag the following information is given: "slightly less hydrophobic than chains consisting of eight atoms, but not bioaccumulative and free of PFT".

Requested and obtained safety data sheets by the author's did not give a conclusive answer regarding the chemical composition of the products. Fortunately a few chemical analyses dealing with the PFASs-content of these products, mainly for footwear and all-weather clothes, have been published already.

Selected data are summarized in Table 37 in the supplement information and discussed below. Additionally some of these products have been analyzed in the authors' laboratory in this study.

- In the impregnating sprays analyzed by Juerling et al. (2011) 6:2; 8:2 and 10:2-FTOH were present in the range between 10 mg/kg up to 1 g/kg; PFOA was in range between 10 to 50 µg/kg (data not shown).
- Nine impregnating sprays were analyzed regarding their PFASs content (Fiedler et al., 2010). Positive findings were obtained in all of the anonymously investigated samples, whereas the spray with the highest concentration showed FTOH values in the range of 85 µg/mL. All PFOS values were below the limit of detection (< LOD) and PFOA values were quite low with concentrations varying between < LOD and 3.6 µg/mL.
- An investigation of five impregnation products presented in 2009 (Herzke et al., 2009) showed that none of the investigated waterproofing agent/lubricant was free from PFASs, however no PFOS was detected in any of the items of this product group.
- The Swedish Society for Nature Conservation (SNF or Svenska Naturskyddsföreningen) has made a study of 13 different waterproofing agents for textiles (Norin and Schulze,

2007). 27 different compounds were analyzed, amongst them PFOA and FTOHs; 8:2-FTOH was detected in eight of the agents, with a concentration above 1,000 µg/mL in two of the agents. Only in two of the waterproofing agents no PFASs were detected.

- With investigations of 21 consumer products, among them eleven impregnating products, performed by Vejrup et al. (2002) PFOS could still be detected in two of eleven products. Two impregnating agents contained 212 µg/mL perfluorodecane sulfonate (PFDS) and 3.5 µg/mL perfluorooctane sulfonamide, respectively.

Information from a company producing impregnating agents primarily for the Scandinavian market has been included in the report of Jensen and Poulsen (2008). Two of their products for textiles had been analyzed resulting in total PFASs values of 2.2 and 5.3 mg/kg, respectively. The dominating PFCA was PFOA with contents of 0.73 and 4 mg/kg in the respective products.

### 3.10 Conclusion of literature research

Especially in Scandinavia, Switzerland and Germany studies regarding the kind and use of PFASs in textile products and impregnation solutions has been performed. However, most of the studies are close to 10 years old and not relevant anymore, since the awareness about the negative features, especially PFOS, PFOA and PFOA-precursor products has led to a change in this field of application. With the envisaged phase-out of PFOA, it can be predicted that the shift towards PFASs with a perfluorinated chain length of  $< C_7$  will be still ongoing.

In summary, not much has been published dealing with textiles and cloths as potential source of PFASs for the environment. Resulting from this, no sufficient and reliable information is available, which could be used for this kind of environmental exposure calculation.

However, based on the many retrieved individual data compiled from the cited references, a rough estimation regarding the performed calculations needed for both, the environmental and human exposure could be performed. The data used for these calculations have been defined at the respective chapters.

## 4 Analysis of PFASs concentrations in outdoor jackets

### 4.1 Materials and methods

#### 4.1.1 Selection of DWR jackets

A total of sixteen outdoor jackets (J0 – J15) were acquired during the period of August 2011 to March 2012. An overview of the jackets analyzed is given in Table 11.

Initially, the authors were aiming to include jackets from EU and Asia in the analysis. However, it was almost impossible to find outdoor jackets being produced completely in Germany, respectively the EU.

Thus the selection of jackets has been performed based on the following criteria:

- price range below 100 euro and above 300 euro
- different producers as well as different textiles
- Fabrics made of PTFE and/or containing PTFE membranes
- Being included in the list of media control (Table 9) and being ranked as market leader
- Having the blue sign label (chapter 3.8.2)
- Being recommended during independently performed tests of journals such as Outdoor and ALPIN
- Being sold by food markets in the low price range
- Being labeled as fluorocarbon free

Upon arrival in the authors' laboratory, all acquired jackets were labeled and documented. Besides the working jacket (J15) and the jackets J4 and J14, all jackets were new and packed in a plastic shell.

In order to avoid contaminations from lab chemicals, the jackets were stored in a separate room. Contacts with the jackets were exclusively by lab chemists wearing gloves.

These jackets were analyzed regarding their PFASs concentrations in order to come up with a possible correlation regarding origin of production as well as price and fabrics.



Understanding exposure pathways of PFASs via use of PFASs-containing products –risk estimation for man and environment

Table 11. Tested outdoor jackets, J0-J15, information concerning function, membrane, origin etc.

Jacket number	PTFE membrane	Outdoor jacket type	Price	Information	Weight	Origin	Status	Size
0		rainjacket	low	100% polyester, signed to have a fluorofree impregnation	176 g	People's Republic of China	in shop	134/140 (kids)
1		rainjacket	low	100% polyester, Öko Tex 100	470 g	n.s.	new, packed	L
2		rainjacket	high	3 layer, 100% nylon	426 g	People's Republic of China	new, packed	L
3		softshell jacket	low	96% polyester and 4% elasthan	428 g	Fabric manufacturing in Bulgaria or Tunesia, tailored and sewn in Italy	new, packed	140 (kids)
4		hardshell jacket	low	96% nylon	713 g	n.s., *	jacket arrive unpacked in shop, was on sale since for 4 weeks	52/54
5		hardshell jacket	medium	100% polyamid with coating of PU	856 g	Vietnam	new, packed	XL
6		hardshell jacket	medium	100% polyamid with coating of PU	888 g	Vietnam	new, packed	XL
7	x	rainjacket	high	100% polyamid with PTFE membrane	328 g	Ukraine	new, packed	L
8	x	hardshell jacket	high	100% nylon with PTFE membrane	516 g	Vietnam	new, packed	M
9		rainjacket	medium	2.5 laminat of 100% nylon, DWR impregnation	286 g	People's Republic of China	new, packed	M

Understanding exposure pathways of PFASs via use of PFASs-containing products –risk estimation for man and environment

Jacket number	PTFE membrane	Outdoor jacket type	Price	Information	Weight	Origin	Status	Size
10		hardshell jacket	medium	2 layers laminat of 100% polyester and 100% PU	620 g	People's Republic of China	new, packed	50
11		rainjacket	low	100% nylon	417 g	Indonesia	new, packed	L
12		hardshell jacket	low	100% polyester, PU coated, finished with Teflon®	1097 g	n.s.	new, packed	L
13		rainjacket	high	100% polyamid outer shell, 100% PU membrane, blue sign®	264 g	Taiwan	new, packed	L
14	x	hardshell jacket	high	90% of jacket exists of PTFE membrane	498 g	n.s., *	since 11.02.2010 on sale	42
15		working jacket	high	54% Polypropenoie Acid Nitrile, 45% cotton	1813 g	n.s.	Privat	XL

Prices: < 100 euro low, 100-200 euro medium, > 200 euro high; n.s. not specified; \*on telephone request no declaration of origin possible

#### 4.1.2 Substances and standards

Three different methods were developed to extract the PFASs from outdoor jackets and determine the concentration of PFASs by LC-MS/MS. A list of formulae of investigated substances is given in Table 12. The first method, with the abbreviation PFAS-a, includes the PFCAs ( $C_4 - C_{14}$ ) and PFSAs ( $C_4, C_6, C_7, C_8, C_{10}$ ), and the  $^{13}C$  and  $^{18}O$  (M) labeled internal standards MPFBA, MPFHxA, MPFOA, MPFNA, MPFDA, MPFUnA, MPFD $\alpha$ A, MPFHxS, and MPFOS from Wellington Laboratories. The second method, with the acronym PFAS-n, includes the FTOHs (6:2-, 8:2-, 10:2-FTOH) and FOSEs (N-MeFOSE and N-EtFOSE) utilizing  $^{13}C$  and  $^2H$  labeled M-8:2-FTOH as internal standard. The third method, with the acronym PFAS-f includes the FOSA-derivatives (FOSA, N-MeFOSA and N-EtFOSA). The whole set of certified compounds is listed in Table 13. Detailed information regarding instrumental parameters and assignment of internal standards is shown in Table 16 and Table 17.

Table 12. List of investigated substances and the corresponding LC-MS/MS method

Compound class	Acronym	Chemical structure	No. native ( <i>n</i> )	No. mass labeled ( <i>n</i> )	LC-MS/MS method
Perfluorocarboxylic acids	PFCAs	$F-(CF_2)_n-C(=O)OH$	11 (3-13)	7 (3,5,7-11)	PFAS-a
Perfluoroalkane sulfonic acids	PFSAs	$F-(CF_2)_n-S(=O)_2OH$	4 (4,6,8,10)	2 (6, 8)	PFAS-a
Perfluoroalkane sulfonamides	FASAs	$F-(CF_2)_n-S(=O)_2NH-R$	3 (8, R=H, Me, Et)	/	PFAS-f
Perfluoroalkane sulfonamidoethanols	FASEs	$F-(CF_2)_n-S(=O)_2N(R)CH_2CH_2OH$	(8, R= Me, Et)	/	PFAS-n
Fluorotelomer alcohols	FTOHs	$F-(CF_2)_n-CH_2-CH_2-OH$	3 (6,8,10)	1 (8)	PFAS-n

Table 13. List of certified PFASs standards.

Product Name	Compound	Acronym	Concentration [↔g/mL]
PFT-Mix 11 (Neochema)	n-Perfluorobutanoic acid	PFBA	10
	n-Perfluoropentanoic acid	PFPeA	10
	n-Perfluorohexanoic acid	PFHxA	10
	n-Perfluoroheptanoic acid	PFHpA	10
	n-Perfluorooctanoic acid	PFOA	10
	n-Perfluorononanoic acid	PFNA	10
	n-Perfluorodecanoic acid	PFDA	10
	n-Perfluoroundecanoic acid	PFUnA	10
	n-Perfluorododecanoic acid	PFDoA	10
	n-Perfluorotridecanoic acid	PFTTrA	10
n-Perfluorotetradecanoic acid	PFTTeA	10	
PFS-MXA (Wellington)	Potassium perfluoro-1-butanedisulfonate	PFBS	2
	Sodium perfluoro-1-hexanesulfonate	PFHxS	2
	Sodium perfluoro-1-heptanesulfonate	PFHpS	2
	Sodium perfluoro-1-octanesulfonate	PFOS	2
	Sodium perfluoro-1-decanedisulfonate	PFDS	2
6:2-FTOH (Neochema)	1H,1H,2H,2H-Perfluoro-1-octanol	6:2-FTOH	50
8:2-FTOH (Neochema)	1H,1H,2H,2H-Perfluoro-1-decanol	8:2-FTOH	50
10:2-FTOH (Neochema)	1H,1H,2H,2H-Perfluoro-1-dodecanol	10:2-FTOH	50
MFOET (Wellington)	2-Perfluorooctyl-[1,1,- <sup>2</sup> H <sub>2</sub> ]-[1,2- <sup>13</sup> C <sub>2</sub> ]-ethanol	M-8:2-FTOH	50
MPFAX-MXA (Wellington)	Sodium perfluoro-1-hexane[ <sup>18</sup> O <sub>2</sub> ]sulfonate	MPFHxS	2
	Sodium perfluoro-1-[1,2,3,4- <sup>13</sup> C <sub>4</sub> ]octanesulfonate	MPFOS	2
	Perfluoro-n-[ <sup>13</sup> C <sub>4</sub> ]butanoic acid	MPFBA	2
	Perfluoro-n-[1,2- <sup>13</sup> C <sub>2</sub> ]hexanoic acid	MPFHxA	2
	Perfluoro-n-[1,2,3,4- <sup>13</sup> C <sub>4</sub> ]octanoic acid	MPFOA	2
	Perfluoro-n-[1,2,3,4,5- <sup>13</sup> C <sub>5</sub> ]nonanoic acid	MPFNA	2
	Perfluoro-n-[1,2- <sup>13</sup> C <sub>2</sub> ]decanoic acid	MPFDA	2
	Perfluoro-n-[1,2- <sup>13</sup> C <sub>2</sub> ]undecanoic acid	MPFUnA	2
	Perfluoro-n-[1,2- <sup>13</sup> C <sub>2</sub> ]dodecanoic acid	MPFDoA	2
FOSA-M (Wellington)	Perfluoro-1-octanesulfonamide	FOSA	50
N-MeFOSA-M (Wellington)	N-methylperfluoro-1-octanesulfonamide	N-MeFOSA	50
N-EtFOSA-M (Wellington)	N-ethylperfluoro-1-octanesulfonamide	N-EtFOSA	50
N-MeFOSE-M (Wellington)	2-(N-methylperfluoro-1-octanesulfonamido)-ethanol	N-MeFOSE	50
N-EtFOSE-M (Wellington)	2-(N-ethylperfluoro-1-octanesulfonamido)-ethanol	N-EtFOSE	50

## 4.2 Analytical method development and quality assurance

### 4.2.1 HPLC methods

The instrumental setup was based on a high pressure liquid chromatograph (Perkin Elmer Series 200, Norwalk, CT, USA) combined with a hybrid triple quadrupole linear ion trap tandem mass spectrometer Q Trap 3200 (Applied Biosystems, Foster City, CA, USA) equipped with electrospray ionization (ESI) source in negative ion mode ( $V = -4.5$  kV). A reversed-phase  $C_{18}$  column (MZ-Aqua Perfect, 50 x 2.1mm, MZ Analysentechnik, Mainz, Germany) with precolumn (MZ-Aqua Perfect, 10 x 2.1 mm) was used for chromatographic separation. Eluents consisted of A:  $H_2O/MeOH$  (95:5; V:V) and B:  $H_2O/MeOH$  (5:95; V:V) both containing 5 mM ammonium acetate.

Two HPLC methods were used during this study. The PFAS-a HPLC method (Table 14) was used to analyze PFCAs ( $C_4 - C_{14}$ ), PFASs ( $C_4, C_6, C_7, C_8, C_{10}$ ) and FOSA-derivatives (FOSA, N-MeFOSA and N-EtFOSA) and the PFAS-n HPLC method (Table 15) was used to analyze FTOHs (6:2-, 8:2-, 10:2-FTOH) and FOSE-derivatives (N-MeFOSE and N-EtFOSE). Injection volume for both methods was 50  $\mu$ L (solvents used for injection were: PFAS-a:  $MeOH:H_2O$ , 1:1; PFAS-n: methanol) at a flow rate of 300  $\mu$ L/min (PFAS-a) and 200  $\mu$ L/min (PFAS-n), respectively.

Table 14. HPLC gradient profile of the PFAS-a HPLC method.

Total Time [min]	A [%]	B [%]
0	100	0
2	100	0
15	0	100
20	0	100
25	100	0
35	100	0

Table 15. HPLC gradient profile of the PFAS-n HPLC method.

Total Time [min]	A [%]	B [%]
0	50	50
2	50	50
8	0	100
10	0	100
12	50	50
25	50	50

### 4.2.2 MS/MS methods

After liquid chromatographic separation, a hybrid triple quadrupole/linear ion trap tandem mass spectrometer (QqQ<sub>lit</sub>-MS) (Applied Biosystems 3200 Q TRAP, software Analyst, version 1.5.1) in multiple reaction monitoring (MRM) mode with negative ESI ( $V = -4.5$  kV) was used for determination of the PFASs. Two different MS/MS methods were used, PFAS-a MS/MS method was used for the experiments, which includes the PFCAs ( $C_4 - C_{14}$ ), PFASs ( $C_4, C_6, C_7, C_8, C_{10}$ ) and FOSA-derivatives (FOSA, N-MeFOSA and N-EtFOSA) and the PFAS-n MS/MS method was used for the experiments, which includes the FTOHs (6:2-, 8:2-, 10:2-FTOH) and FOSE-derivatives (N-MeFOSE and N-EtFOSE).

An overview of the PFAS-a – and PFAS-n MS/MS methods, internal standards and retention times is given in Table 16 and Table 17.

Table 16. Overview of quantifier and qualifier transitions, internal standards attributed to target analytes as well as retention times of target compounds for PFAS-a HPLC-MS/MS method.

Substance	MW [g/mol]	MRM transition [m/z, [M-H] <sup>-</sup> ]		Internal Standard	Retention time [min]
		Quantifier	Qualifier		
PFBA	214.03	213 > 169	-	MPFBA	6.3
PFPeA	264.04	263 > 219	-	MPFHxA	11.1
PFHxA	314.05	313 > 269	313 > 119	MPFHxA	12.5
PFHpA	364.06	363 > 319	363 > 169	MPFHxS	13.3
PFOA	414.07	413 > 369	413 > 169	MPFOA	14.0
PFNA	464.07	463 > 419	463 > 169	MPFNA	14.6
PFDA	514.08	513 > 469	513 > 269	MPFDA	15.2
PFUnA	564.09	563 > 519	563 > 319	MPFUnA	15.7
PFDoA	614.1	613 > 569	613 > 219	MPFDoA	16.1
PFTra	664.1	663 > 619	663 > 169	MPFDoA	16.5
PFTeA	714.11	713 > 669	713 > 169	MPFDoA	16.9
PFBS	300.10	299 > 80	299 > 99	MPFHxA	11.6
PFHxS	400.12	399 > 80	399 > 99	MPFHxS	13.4
PFHpS	450.12	449 > 80	449 > 99	MPFOA	14.0
PFOS	500.13	499 > 80	499 > 99	MPFOS	14.6
PFDS	600.14	599 > 80	599 > 99	MPFUnA	15.6
FOSA	499.15	498 > 78	-	MPFDoA	15.6
N-MeFOSA	513.17	512 > 169	512 > 219	MPFDoA	16.4
N-EtFOSA	527.2	526 > 169	527 > 219	MPFDoA	16.7

Table 17. Overview of quantifier and qualifier transitions, internal standards attributed to target analytes as well as retention times of target compounds for PFAS-n HPLC-MS/MS method.

Substance	MW [g/mol]	MRM transition [m/z, [M+Ac] <sup>+</sup> ]	Internal standard	Retention time [min]
6:2-FTOH	364.1	423 > 59	M-8:2-FTOH	8.8
8:2-FTOH	464.12	523 > 59	M-8:2-FTOH	10.0
10:2-FTOH	564.14	623 > 59	M-8:2-FTOH	10.8
N-MeFOSE	557.23	616 > 59	M-8:2-FTOH	10.1
N-EtFOSE	571.25	630 > 59	M-8:2-FTOH	10.4

#### 4.2.3 Sample preparation and extraction of PFAS-a

Two squares of 5 x 10 cm from the lower backside of each jacket were cut out with a pair of scissors. The squares were weighed precisely and cut to small pieces. Each sample was spiked with a mixture of internal standards. Five spots with respectively 10 µL of this mixture were placed on the outer shell of the sample. The internal standard mixture contained MPFBA, MPFHxA, MPFOA, MPFNA, MPFDA, MPFUnA, MPFDoA, MPFHxS, and MPFOS with a concentration of 0.02 ng/µL dissolved in MeOH. This resulted in an amount of 1 ng internal standard in each sample. The small pieces were transferred into 15 mL polypropylene vials after the solvent of the standard mixture was evaporated. 10 mL of acetone/acetonitrile (80:20; V:V) was added to the vials and sonicated for one hour.

Following the extraction step, the solution was pipetted into a 24 mL glass vial with screw cap and the small pieces were washed with 5 mL acetone/acetonitrile (80:20; V:V). The washing solution was combined with solvent from first extraction and mixed one minute by using a vortex mixer during the washing. These 5 mL were transferred into the same 24 mL glass vial. The resulting 15 mL of solvent were evaporated with a gentle nitrogen flow at 50 °C. The residue was dissolved in 500 µL MeOH/H<sub>2</sub>O (50:50; V:V) and mixed for two minutes by using a vortex mixer. The solutions were filtered with a syringe cellulose filter (pore size of 0.45 µm, bore of 13 mm, supplier: Schleicher & Schuell) and finally transferred in a 500 µL polypropylene HPLC vial and measured with the LC-MS/MS system using the PFAS-a HPLC and PFAS-a MS/MS method.

A series of standards in a range of 10 ng/m<sup>2</sup> to 8 µg/m<sup>2</sup> with 14 concentration levels was prepared in MeOH/H<sub>2</sub>O (50:50; V:V) and measured five times, respectively. Only the results with accuracy of ± 30% and at least three of five measurements for each concentration level with a signal to noise ratio > 5 (LOQ) were quantified and included in the calibration curve.

#### 4.2.4 Sample preparation and extraction of PFAS-n

Two squares of 5 x 10 cm from the lower backside of each jacket were cut out with a pair of scissors. The square was weighed and cut to small pieces. The small pieces were transferred into 15 mL polypropylene vials and 10 mL n-hexane was added. An internal standard solution with a concentration of 5 µg/mL M-8:2-FTOH in MeOH was prepared and 24 µL was pipetted directly into the extraction solvent, resulting in a concentration of 120 ng M-8:2-FTOH in each sample. After sonication for one hour, the 10 mL n-hexane was transferred into a 24 mL glass vial. The small pieces were washed with 5 mL n-hexane using a vortex mixer for two minutes and the solution was transferred into the same glass vial. Subsequently, solid phase extraction (SPE) was applied in order to eliminate matrix compound and to concentrate the sample. As shown in chapter 12.7.1 of the supplement information, evaporation of the solvent is not applicable to FTOHs, thus, the elution volume was reduced to a minimum. A silica cartridge (Bond Elut<sup>®</sup> Si, 40 µm, 1 g sorbent mass, 6 mL volume, Agilent Technologies, Waldbronn, Germany) was used for the SPE.

For SPE, Agilent Bond Elut<sup>®</sup> Si (1 g, 6 mL) normal phase cartridges were conditioned with 3 mL acetone, and twice 3 mL n-hexane. The samples were enriched and after drying the cartridges for 3 minutes by compressed air, analytes were eluted with 2 x 1.5 mL MeOH. Eluates were mixed with a vortex shaker and directly measured by PFAS-n HPLC and PFAS-n MS/MS method.

#### 4.2.5 Quantitative method PFAS-f

To determine the concentration of FOSA-derivatives (FOSA, N-MeFOSA and N-EtFOSA) the PFAS-n extraction method was combined with the PFAS-a HPLC MS/MS method.

A series of standards in a range of 10 ng/m<sup>2</sup> to 10 µg/m<sup>2</sup> with ten concentration levels was prepared in MeOH and measured. Only the standards with accuracy of ± 30% were implemented in the calibration curve and at least three of five measurements for each concentration level with a signal to noise ratio > 5 were quantified and implemented in the calibration curve



#### 4.2.6 Quantification of PFASs in the jackets analyzed

For the determination of PFASs in the considered jackets, two samples of each jacket were prepared with the sample preparation of the three methods PFAS-a, PFAS-n and PFAS-f, extracted and measured using the corresponding LC-MS/MS method. During all sample preparations a reference without textile sample (blank) was treated simultaneously in order to quantify possible cross-contaminations. During all LC-MS/MS analyses standard solutions were measured to validate the chromatography of the HPLC and the MS/MS method. A pre-column was inserted before the injector in the HPLC system to exclude contaminations of PFASs in the eluent and HPLC system. During each step of the sample preparation all devices were washed with acetone several times and the protection gloves were changed during the different preparation steps as well. All polypropylene vials and the weighing pans were used once.

Since within the spiking experiments during the method development a contamination of PFHpA with an unresolved source was detected, the measured PFHpA concentrations were excluded from the following results.

The results obtained during the different steps of the method development, as well as the quality assurance experiments, such as blank concentrations, recovery rates of IS in the samples are given either in section results or the supplementary material.

### 4.3 Results

#### 4.3.1 Calibration curves and limits of quantification

An overview of the LOQs is given in Table 18. LOQs are defined as the lowest calibration point that showed an accuracy of  $\pm 30\%$  for at least three of five replicate measurements and a signal to noise ratio  $> 5$ .

Table 18. Overview of limits of quantification (LOQ) for DWR jackets.

Substance	LOQ [ng/mL]	LOQ [ $\mu\text{g}/\text{m}^2$ ]	Determination method
PFBA	0.5	0.1	PFAS-a
PFPeA	0.5	0.1	PFAS-a
PFHxA	0.1	0.02	PFAS-a
PFHpA	0.5	0.1	PFAS-a
PFOA	0.1	0.02	PFAS-a
PFNA	0.05	0.01	PFAS-a
PFDA	0.5	0.1	PFAS-a
PFUnA	1	0.2	PFAS-a
PFDoA	0.5	0.1	PFAS-a
PFTTrA	0.1	0.02	PFAS-a
PFTTeA	0.5	0.1	PFAS-a
PFBS	0.1	0.02	PFAS-a
PFHxS	0.05	0.01	PFAS-a
PFHpS	0.5	0.1	PFAS-a
PFOS	0.1	0.02	PFAS-a
PFDS	0.05	0.01	PFAS-a
FOSA	0.1	0.02	PFAS-f
N-MeFOSA	1	0.2	PFAS-f
N-EtFOSA	0.5	0.010	PFAS-f
6:2-FTOH	1	0.2	PFAS-n

8:2-FTOH	2	0.4	PFAS-n
10:2-FTOH	2	0.4	PFAS-n
N-MeFOSE	0.05	0.01	PFAS-n
N-EtFOSE	0.05	0.01	PFAS-n

The resulting correlation coefficients of calibration curves are shown in Table 43 in the supplement information and ranged from 0.9914 to 0.9986. The software Analyst 1.5.1 (AB Sciex, Toronto, Canada) was used for the calculation with a weighting by 1/x. The limits of quantification ranged from 10 ng/m<sup>2</sup> to 400 ng/m<sup>2</sup>, depending on the compound. The differences in LOQs are largely attributed to different ionization and fragmentation efficiencies during MS analysis.

#### 4.3.2 Validation of the PFAS-a extraction method

To test the extraction with sonication for one hour, a triplicate determination of the recovery was realized. Three samples of jackets J5 and J6 were prepared as stated in the sample preparation PFAS-a and spiked with 10 µL of a spiking solution containing PFCAs (C<sub>4</sub> – C<sub>14</sub>), PFSAs (C<sub>4</sub>, C<sub>6</sub>, C<sub>7</sub>, C<sub>8</sub>, C<sub>10</sub>), FOSA-derivatives (FOSA, N-MeFOSA and N-EtFOSA), and the internal standards with a concentration of 0.02 µg/mL dissolved in MeOH. FOSA-derivatives were later excluded from this method due to insufficient recoveries. These samples were spiked on five spots of the upper shell with the spiking solution, and resulted respectively in an amount of 1 ng PFCAs, PFSAs, FOSA-derivatives and internal standards per sample. Following the LC-MS/MS analysis, concentrations were calculated based on the calibration curves without correction by internal standards in order to determine the percentage of substance recovered from the textile and not to assess the suitability of an internal standard for a certain analyte. The concentrations in the unspiked samples were subtracted from the concentration in the spiked samples, which were treated simultaneously without spiking. Recovery was calculated by dividing the resulting calculated concentration difference by the effective concentration added. Thus, the results are not compensated by correction with the internal standards and are shown in Figure 7.

Figure 7. Recovery of PFAS-a extraction by sonication for one hour (n=3). Recovery was calculated by a comparison of concentrations determined in spiked and unspiked samples and a calibration curve based on peak areas of the analytes. Peak area ratios relative to internal standards were not used for this calculation.

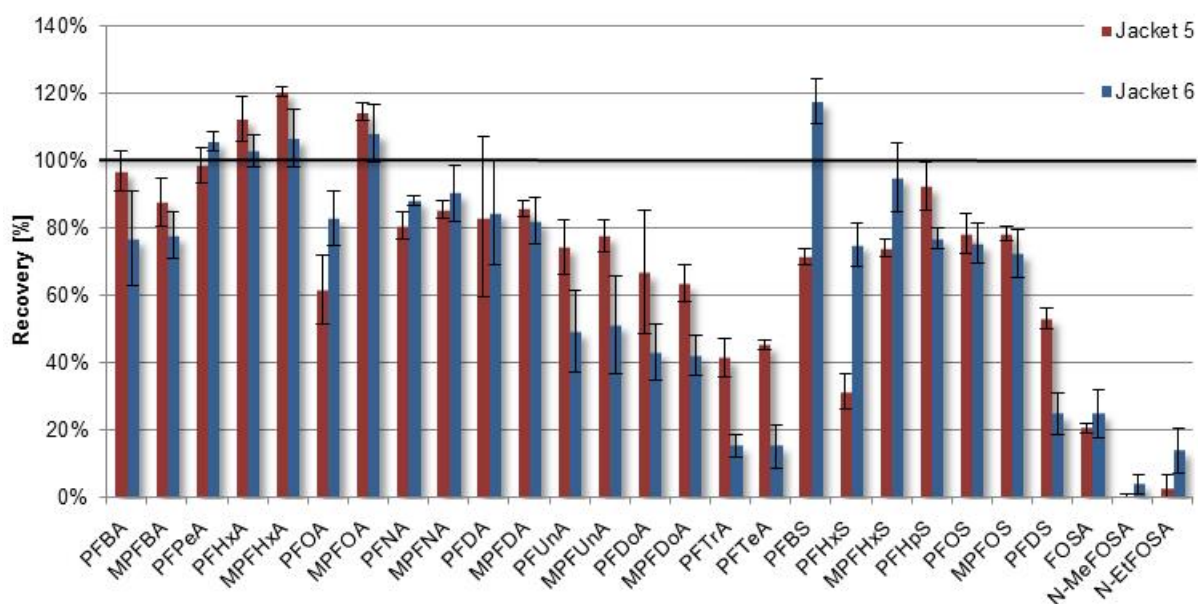

The recovery results of the triplicate extraction indicated a sufficient repeatability of the extraction method (RSDs below 20%). PFCAs from PFBA to PFDA generally showed recovery levels between 80 and 120%, whereas longer-chained PFCAs showed a decline in recovery. For example PFTTrA and PFTeA only showed recovery rates below 50%, and thus these PFASs could only be semi-quantified. The cause for those low recovery rates might be attributed to stronger sorption to the textile material or other surfactes or due to losses during workup of the sample, e.g. hampered dissolution after evaporation of the extract. The same applies to PFDS.

The PFAS-a extraction method yielded very low recoveries for the FOSA derivatives with values up to only 33%. One reason for these very low recovery rates might be the evaporation of the substances during the evaporation of the extraction solvent at elevated temperatures (40 °C). This problem could be solved through development of the PFAS-f method.

#### 4.3.3 Validation of the PFAS-a method with internal standards

Three samples of the jackets J0, J7 and J13 were prepared according to the sample preparation of the PFAS-a extraction method. Two samples of each jacket were spiked with a spiking solution containing PFCAs (C<sub>4</sub> – C<sub>14</sub>) and PFSAs (C<sub>4</sub>, C<sub>6</sub>, C<sub>7</sub>, C<sub>8</sub>, C<sub>10</sub>). The concentration of each analyte and the corresponding internal standards dissolved in MeOH was 0.04 µg/mL and 0.02 µg/mL, respectively. These samples were spiked on five spots of the upper shell with 10 µL of the spiking solution, resulted respectively in an amount of 2 ng PFCAs, PFSAs, FOSA-derivatives and 1 ng internal standards per sample. Additionally, unspiked samples were prepared simultaneously. These were spiked with internal standards only. After LC-MS/MS analysis (PFAS-a HPLC and MS/MS method), the concentrations were calculated using calibration curves taking into account peak area ratios between analytes and internal standards. The concentrations in the unspiked samples were subtracted from the concentrations in spiked samples, and the resulting concentration differences were divided by the effective concentration added to the spiked samples. For this experiment the concentrations found were compensated by the

internal standards. In this way, the trueness of the method is assessed as well as the suitability of the internal standards for a certain analyte to be used for quantification purposes. The calculated recovery results are shown in Figure 8. As a result of the compensation of losses by the internal standards, recoveries were generally between 70-130%. Problems mainly occurred for long-chained PFCAs (PFTrA and PFTeA) and PFDS, for which no isotope-labelled internal standard was available. One outlier was observed for PFDA at a very high recovery rate of 160%.

Figure 8. Recovery results of PFAS-a extraction method with spiked samples (n=2) relative to internal standard, expressing trueness of the method.

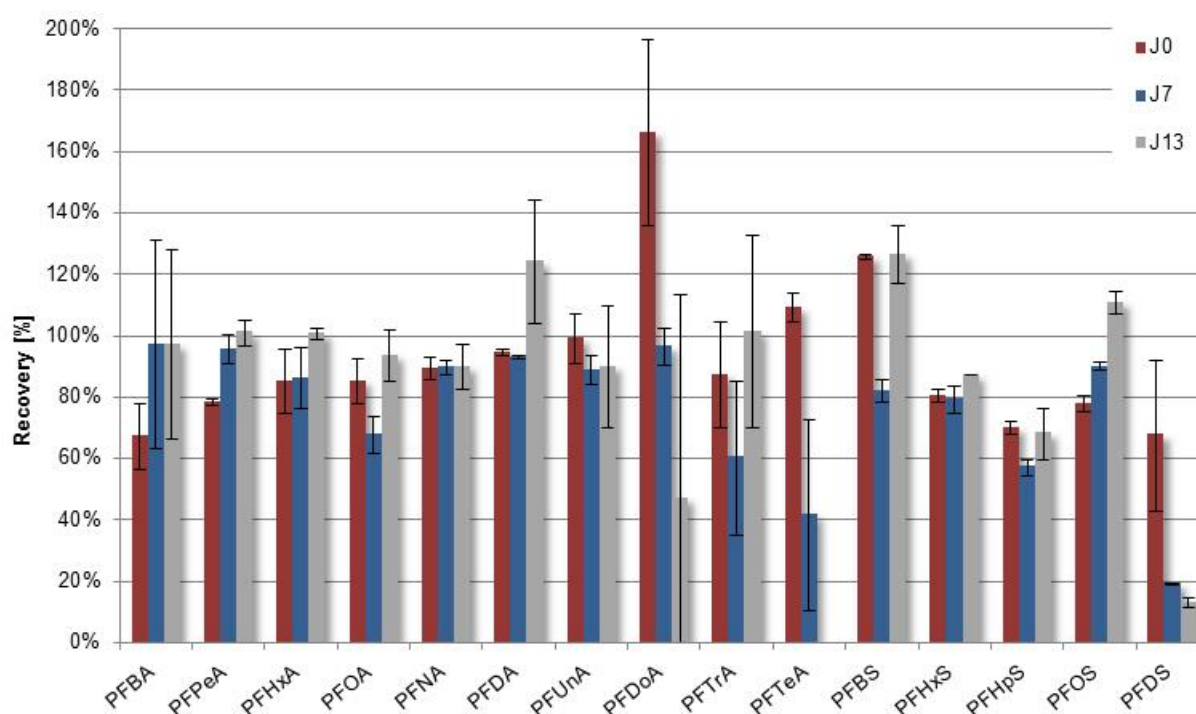

For the validation of the PFAS-a method the extract of a spiked and extracted sample of jacket J7 was measured with LC-MS/MS on two different days. The determined values of the different measurements were compared and the relative standard deviations (RSD) calculated (Table 19). Variations were found to be in an acceptable range between 0.2% and 5.1%.

Table 19. Relative standard deviation (RSD) of the measured extract from a spiked sample of jacket J7 on two different days, extracted and analyzed with PFAS-a quantification method.

Analyte	RSD
PFBA	2.0%
PFPeA	1.1%
PFHxA	0.6%
PFOA	1.6%
PFNA	2.5%
PFUnA	1.1%
PFDoA	0.2%
PFTrA	1.4%
PFTeA	4.7%

PFBS	0.9%
PFHxS	1.2%
PFHpS	1.2%
PFOS	2.2%
PFDS	1.4%

#### 4.3.4 Validation of the PFAS-n extraction method with spiked solvent

Four squares of 5 x 10 cm from the lower backside of jacket J5 and jacket J6 were cut out with a pair of scissors. The squares were cut to small pieces and transferred in 15 mL polypropylene vials and 10 mL n-hexane was added to each vial. Three samples of each jacket were spiked with 24  $\mu$ L of a methanolic spiking solution, which contained FTOHs (6:2-, 8:2-, 10:2-FTOH) and FOSE-derivatives (N-MeFOSE and N-EtFOSE) at a concentration of 5  $\mu$ g/mL as well as 24  $\mu$ L of internal standard solution containing  $^{13}$ C and  $^2$ H-labelled M-8:2-FTOH with a concentration of 5  $\mu$ g/mL solved in MeOH. The spiking solutions were pipetted directly into the polypropylene tubes containing n-hexane. Direct spiking onto the textile surface was not be applied due to rapid volatilization of FTOHs (see supplement information, Figure 22). After extraction by sonication for one hour, transfer of n-hexane into a 24 mL glass vial, the washing step and the SPE, the eluates were measured by the PFAS-n HPLC-MS/MS method. The recovery rates were calculated using a calibration curve based on peak areas. The concentrations obtained for the unspiked samples were subtracted from the concentrations of the spiked sample and the resulting concentration difference was divided by the concentration added (Figure 9).

Figure 9. Recovery results of PFAS-n extraction method with spiking directly in n-hexane before SPE (n=3). Recovery was calculated by comparison of concentrations determined in spiked and unspiked samples and a calibration curve based on peak areas of the analytes. Peak area ratios relative to internal standards were not used for this calculation.

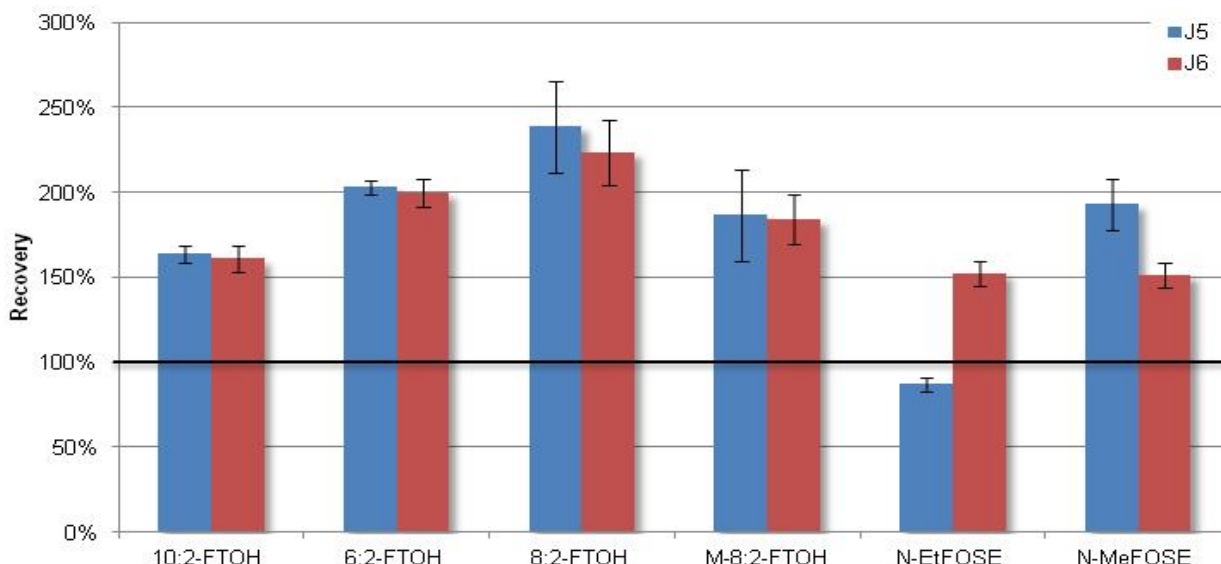

The results of this experiment showed recovery rates in the range of 87 – 239% with minor deviations of the three prepared and measured samples. The high recoveries were compensated by the correlation to the internal standard M-8:2-FTOH in the real samples. The accuracy of the quantitative measurement of these compounds is highly improved by application of internal standards as a result of the rather odd behavior during ESI-MS analysis.

In contrast to acidic compounds, which can be measured as the deprotonated molecule, this was not achieved with satisfying sensitivity for FTOHs (data not shown), therefore FTOHs and FOSEs were measured as their acetate adduct  $[M+CH_3COO]$ . This in turn can cause problems in real samples as a result of ionization efficiencies when co-eluting compounds compete for acetate adduct formation. Furthermore, collision-induced dissociation of acetate adducts only yields acetate adducts as a product ion, which is not a selective transition for FTOH. In order to overcome these problems, all extracts were also measured after spiking with non-labeled compounds. In this way, retention time shifts and matrix effects were further compensated.

Repeatability of the method was investigated by analysis of six different samples of jacket J7 using the quantitative method PFAS-n (Figure 10).

Figure 10. Replicate determination of PFASs concentration by using the PFAS-n determination method (n=6).

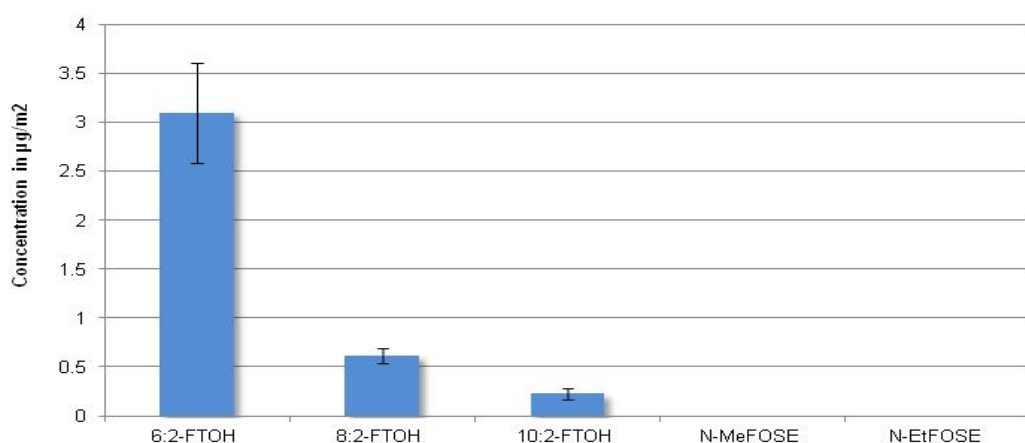

The results of this experiment showed a repeatable quantitative method for FTOHs with RSDs of 25%, 16% and 12% for 6:2-FTOH, 8:2-FTOH and 10:2-FTOH, respectively. These relative high values might result from the six different textile squares of the jacket used for the sample preparation. Additionally, since only one internal standard was used for this method, it cannot completely be ruled out that all matrix effects have been compensated.

#### 4.3.5 Validation of PFAS-f method

Four samples of jacket J5 and J6 were prepared with the PFAS-n method. Three of the four samples were, in addition of the internal standard, spiked with 15 ng of each FOSA-derivative (N-MeFOSA, N-EtFOSA and FOSA) per sample. 15 µL of a spiking solution, which contains N-MeFOSA, N-EtFOSA and FOSA was solved in MeOH with a concentration of 1 µg/mL and pipetted directly into n-hexane before extraction. After the SPE, 500 µL was transferred into a HPLC vial and measured with the PFAS-a MS/MS method. The spiked sample was now compared to the unspiked samples.



Figure 11. Recovery results of FOSA-derivatives by combination of PFAS-n extraction with PFAS-a MS/MS method (n=3).

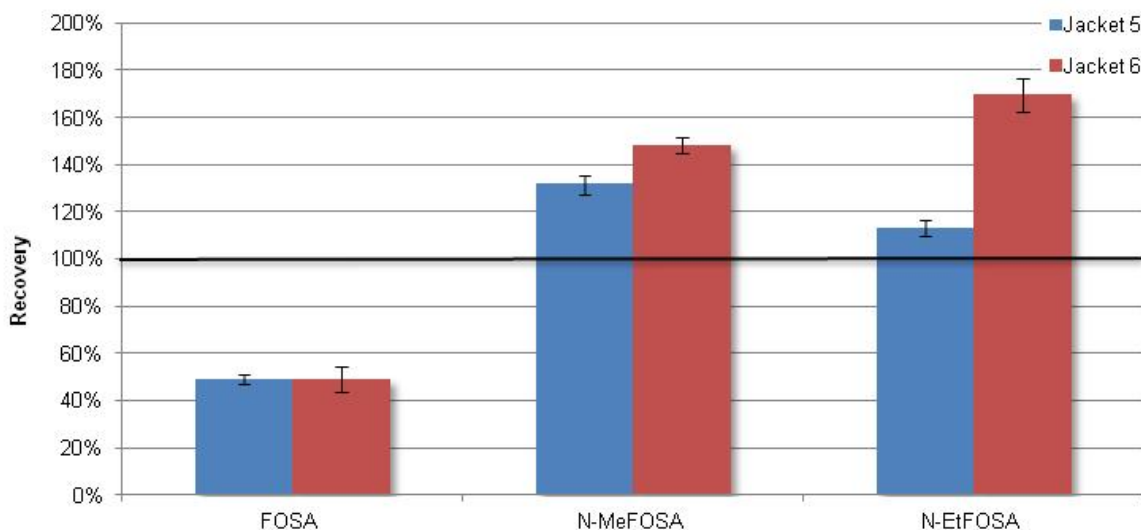

The results showed a recovery of 49% for FOSA, 132-148% for N-MeFOSA and 113-169% for N-EtFOSA depending on the jacket (Figure 11). For the calculation of the recovery no labeled FOSA was used. The peak areas of the spiked samples were compared to the unspiked samples. The deviations of all measurements were in a small range. Based on these results, the determination of FOSA-derivatives was performed by combination of the PFAS-n extraction with PFAS-a MS/MS method and each jacket was analyzed twice.

For further quantification purposes, a series of standards with ten concentration levels in a range of 10 ng/m<sup>2</sup> to 10 µg/m<sup>2</sup> was prepared.

#### 4.3.6 Results of outdoor jacket analysis

Following the thoroughly developed and validated analytical methods, it was possible to analyze 23 PFASs, differing extremely in both, polarity and volatility in the complex textile matrix. Blanks were below LODs for all substances except for PFHpA, which showed noticeable method blank levels, which led to exclusion of PFHpA from all quantitative determinations.

Even though during the method development the authors tried to cover different textiles, as well as dyes etc. of the jackets investigated, the recovery of analytes might still vary from each tested textile sample. However, through the use of isotope labeled standards, the quantitative results of this study will be reliable. Additionally, the amount of PFASs being used as cocktail during the finishing process might have varied depending on the different locations of the jackets. However, the low standard deviations of the two samples being analyzed independently show that this variation did not seem to play a role during the analyses (see Table 44 in the supplement material).

The individual results for all jackets being analyzed are summarized in Table 20 as µg/m<sup>2</sup>. Besides calculating the concentration per meter square, also the concentrations per kg were determined. The entire set of values including the standard deviations (SD) are given in the supplement information (see Table 44 in the supplement information).

By using the developed quantification methods, the determination of PFASs concentrations in all 16 jackets was possible. As discussed above, the application of a broad set of labeled internal standards was crucial to compensate matrix effects during the analysis.



In all analyzed jackets PFASs were determined in a range of 0.03  $\mu\text{g}/\text{m}^2$  to 719  $\mu\text{g}/\text{m}^2$ . Despite these relatively high sum concentrations, analytes of the class of PFSA could only, when present, be detected in concentrations up to 0.5  $\mu\text{g}/\text{m}^2$ . The regulated PFOS was detected in only five jackets in a range of 0.01  $\mu\text{g}/\text{m}^2$  to 0.05  $\mu\text{g}/\text{m}^2$ . If these concentrations stem from impurities or were even introduced during the production of the textiles, is not clear so far.

PFOA was detected in jackets in a concentration range of 0.02  $\mu\text{g}/\text{m}^2$  to 4.59  $\mu\text{g}/\text{m}^2$ . Thereby no correlation could be drawn with respect to the individual textile membranes, nor the price and quality of the jacket (see Table 20 as well as Table 11).

A single PFOA value of 171  $\mu\text{g}/\text{m}^2$  and thus being almost fortyfold above the so far highest value detected, results from an analysis of one working gear jacket. In this single jacket being analyzed, also the other investigated PFACs were quite prominent. This leads to the suggestion that for the extreme water and oil repellency being needed, a different chemical formulation had been utilized during the finishing process.

The PFASs subgroup with the highest concentrations determined were by far the FTOHs, with sum concentrations of a factor of several dozen above the PFCAs. Only for J0 this was not the case. Interestingly, the FTOH concentration in the working gear jacket was low, whereas in one single jacket (J14), which had been bought as “old-fashioned jacket” from an older collection, by far the highest PFASs concentrations were quantified.

A relation of the PFASs concentration to the manufacture of the jackets or the used material of the textiles could not be found. A positive correlation observed between the individual PFOA, PFNA and PFDA concentrations as well as the 8:2- to 10:2-FTOH concentrations suggests that the formulation of PFASs being used seemed to be the same, however only differing in the total amount being introduced (see Table 20).

The fact that almost no 6:2-FTOH was detected in the analyzed jackets indicates that the predicted phase-out of the PFASs- $\text{C}_8$  chemistry had not been initiated at the time the jackets were bought. Individual queries at the manufacturers underpinned this observation. In the meantime, an analysis of the new series of DWR jackets could give more insight into this change of chemical formulations used for DWR jackets.

Detected concentrations of potential PFOS precursors, such as FOSA- and FOSE-derivatives were, when detectable, almost exclusively below the LOQ.

However, all the results showed only the concentration of extractable and targeted PFASs and cannot exhibit the whole concentration of PFASs – including polymeric precursors - in the textile samples. This is due to the MRM approach in the tripole quadrupole mass spectrometer, which allows to monitor only targeted substances. Approaches to tackle this problem are discussed in the conclusion of this report.

Understanding exposure pathways of PFASs via use of PFASs-containing products –risk estimation for man and environment

Table 20. Concentration of PFASs in analyzed outdoor jackets; Jacket No ( $\mu\text{g}/\text{m}^2$ , n=2).

PFASs	J0	J1	J2	J3	J4	J5	J6	J7	J8	J9	J10	J11	J12	J13	J14	J15
PFBA	n.d.	n.d.	n.d.	0.13	n.d.	n.d.	n.d.	n.d.	n.d.	n.d.	n.d.	0.28	n.d.	n.d.	n.d.	1.52
PFPeA	n.d.	0.01	< L0Q	0.11	< L0Q	n.d.	< L0Q	< L0Q	0.03	n.d.	n.d.	0.46	n.d.	n.d.	0.17	4.23
PFHxA	n.d.	0.06	0.28	0.94	0.12	0.01	0.17	0.17	0.40	0.24	0.02	0.37	n.d.	0.03	0.59	14.7
PFOA	0.02	0.15	1.45	0.68	0.50	0.13	1.00	0.22	1.03	1.43	0.23	2.31	0.84	0.10	4.59	171
PFNA	n.d.	0.02	0.15	0.09	0.07	0.05	0.09	0.03	0.09	0.12	0.05	1.05	0.06	0.03	3.57	27.7
PFDA	< L0Q	0.07	0.80	0.32	0.33	< L0Q	0.78	0.10	0.34	0.88	0.12	0.58	0.28	< L0Q	4.48	85.3
PFUnA	n.d.	n.d.	< L0Q	n.d.	< L0Q	n.d.	< L0Q	n.d.	n.d.	n.d.	n.d.	0.36	n.d.	n.d.	2.40	20.3
PFDoA	n.d.	< L0Q	0.37	0.13	0.37	n.d.	0.57	< L0Q	n.d.	n.d.	n.d.	n.d.	n.d.	n.d.	2.88	80.9
PFTra	< L0Q	n.d.	n.d.	< L0Q	0.11	n.d.	0.03	n.d.	n.d.	n.d.	n.d.	n.d.	n.d.	n.d.	0.68	3.70
PFTeA	0.01	n.d.	0.04	0.08	0.26	n.d.	0.22	n.d.	n.d.	n.d.	n.d.	n.d.	n.d.	n.d.	0.45	20.5
<b>Sum PFCAs</b>	<b>0.03</b>	<b>0.32</b>	<b>3.10</b>	<b>2.48</b>	<b>1.76</b>	<b>0.19</b>	<b>2.86</b>	<b>0.52</b>	<b>1.88</b>	<b>2.67</b>	<b>0.42</b>	<b>5.42</b>	<b>1.18</b>	<b>0.16</b>	<b>19.8</b>	<b>430</b>
6:2-FTOH	n.d.	n.d.	1.29	< L0Q	< L0Q	< L0Q	n.d.	18.6	< L0Q	< L0Q	< L0Q	< L0Q	< L0Q	< L0Q	< L0Q	< L0Q
8:2-FTOH	< L0Q	3.04	39.5	1.70	21.5	18.4	35.3	3.68	36.4	13.2	65.4	30.7	7.44	16.6	516	14.8
10:2-FTOH	< L0Q	1.53	14.1	1.49	2.92	10.1	3.74	1.34	11.4	4.41	10.1	6.51	2.11	4.23	182	7.20
<b>Sum FTOHs</b>	<b>&lt; L0Q</b>	<b>4.56</b>	<b>54.8</b>	<b>3.19</b>	<b>24.4</b>	<b>28.5</b>	<b>39.1</b>	<b>23.6</b>	<b>47.8</b>	<b>17.6</b>	<b>75.5</b>	<b>37.2</b>	<b>9.55</b>	<b>20.8</b>	<b>698</b>	<b>22.0</b>
PFBS	n.d.	n.d.	n.d.	n.d.	n.d.	n.d.	n.d.	n.d.	n.d.	n.d.	n.d.	n.d.	0.51	n.d.	n.d.	n.d.
PFHxS	n.d.	n.d.	n.d.	< L0Q	n.d.	n.d.	n.d.	< L0Q	n.d.	n.d.	n.d.	n.d.	0.00	n.d.	n.d.	n.d.
PFHpS	n.d.	n.d.	n.d.	n.d.	n.d.	n.d.	n.d.	n.d.	n.d.	n.d.	n.d.	n.d.	n.d.	n.d.	n.d.	n.d.
PFOS	n.d.	n.d.	n.d.	0.01	0.02	0.03	< L0Q	n.d.	n.d.	n.d.	n.d.	n.d.	0.05	n.d.	n.d.	0.54
PFDS	n.d.	n.d.	< L0Q	n.d.	n.d.	n.d.	n.d.	n.d.	n.d.	n.d.	n.d.	n.d.	n.d.	0.09	n.d.	0.32
FOSA	< L0Q	n.d.	n.d.	< L0Q	< L0Q	< L0Q	< L0Q	< L0Q	n.d.	n.d.	n.d.	< L0Q	< L0Q	0.02	n.d.	< L0Q
N-MeFOSA	n.d.	n.d.	n.d.	n.d.	n.d.	n.d.	n.d.	n.d.	n.d.	n.d.	n.d.	n.d.	n.d.	n.d.	n.d.	n.d.
N-EtFOSA	n.d.	n.d.	n.d.	n.d.	n.d.	n.d.	n.d.	n.d.	n.d.	n.d.	n.d.	n.d.	n.d.	n.d.	n.d.	n.d.
N-MeFOSE	< L0Q	< L0Q	< L0Q	< L0Q	< L0Q	< L0Q	n.d.	n.d.	n.d.	0.05	0.30	0.23	n.d.	< L0Q	1.55	5.02
N-EtFOSE	n.d.	< L0Q	< L0Q	< L0Q	< L0Q	n.d.	n.d.	n.d.	n.d.	0.00	n.d.	n.d.	2.18	0.02	< L0Q	n.d.
<b>Sum PFASs</b>	<b>0.03</b>	<b>4.88</b>	<b>57.9</b>	<b>5.68</b>	<b>26.1</b>	<b>28.7</b>	<b>41.9</b>	<b>24.1</b>	<b>49.6</b>	<b>20.3</b>	<b>76.2</b>	<b>42.9</b>	<b>13.5</b>	<b>21.1</b>	<b>719</b>	<b>458</b>

As shown exemplarily in Figure 12, the detected PFOA concentrations correlated to PFNA concentrations. The comparison of PFOA with PFNA showed a correlation coefficient of 0.859. A correlation coefficient of 0.875 can be detected by the comparison of PFOA with PFDA (data not shown).

Figure 12. Correlation of concentrations of PFOA with PFNA in investigated jackets

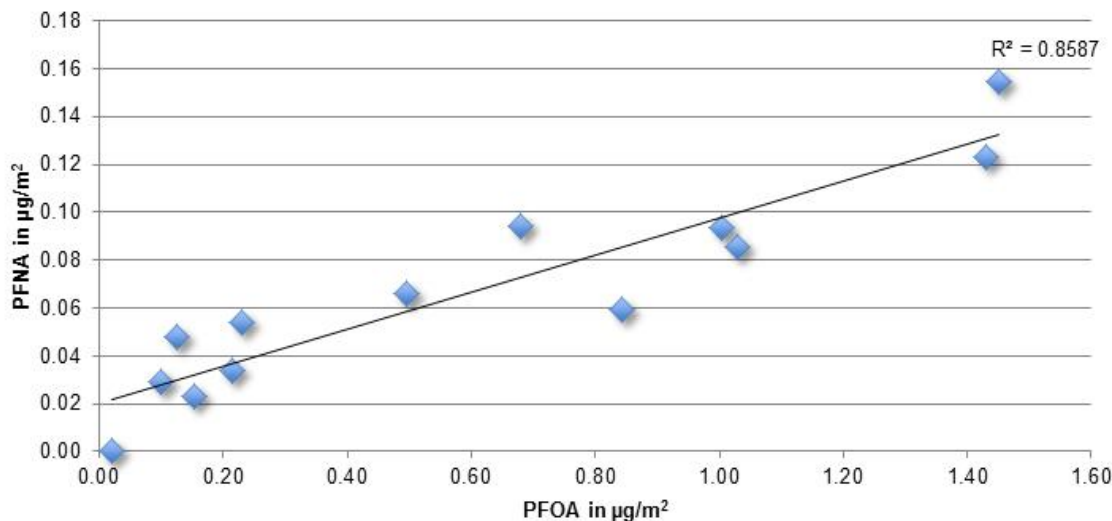

Due to this correlation, it might be assumed that for the textile finishing only one blend of PFASs has been used by all manufacturers – except for the working gear jacket, which is not included in Figure 12.

This will be separately discussed in the chapter exposure calculation, since it is assumed, that the detected PFASs are solely impurities and unreacted intermediates from the membrane fluoropolymers and side-chain fluorinated polymers being introduced onto the membrane.

Overall, a significant difference between the PFASs concentrations stemming from either PTFE or e.g. polyester membranes could not be observed.

## 4.4 Discussion

The first analytical studies on PFASs being conducted with various textiles were published by Berger and Herzke already in the year 2006 (see Table 4 and Figure 13). Among other clothing items the authors have analyzed a rain and outdoor jacket, a sailing jacket, impregnated cotton textiles, Gore Tex textiles as well as various outdoor jackets from individual brands. The methods used were ethyl acetate extraction with GC-MS analysis for FTOHs and other neutral PFASs as well as methanol extraction and subsequent LC-MS detection for PFAA quantification. Method LODs and LOQs as well as other validation data were not reported. Among the investigated textiles very high PFASs concentrations with a share of 8:2-FTOH above 90% were detected in the rain and outdoor jacket and the sailing jacket with sum concentrations above 10,000 and 1,000  $\mu\text{g}/\text{m}^2$  respectively. Also high PFASs concentrations were detected in the cotton T-shirt, where PFOA ( $> 400 \mu\text{g}/\text{m}^2$ ) was predominantly detected. From the other investigated jackets only the sum PFASs concentration in the Gore Tex<sup>®</sup> jacket and a further jacket were above 200  $\mu\text{g}/\text{m}^2$  with an 8:2-FTOH share below 50% and PFOA concentrations above 30  $\mu\text{g}/\text{m}^2$  (Berger and Herzke, 2006). All other determined total PFASs concentrations were below 200  $\mu\text{g}/\text{m}^2$  with a share of 8:2-FTOH between 50 and 90% of the total PFAS amount and PFOA concentrations below 10  $\mu\text{g}/\text{m}^2$ . These concentrations are coherent with the majority of the values determined in the present study (Figure 16). Here only two “outliers” could be detected, where the sum PFASs values were either above 700  $\mu\text{g}/\text{m}^2$  or the PFOA concentration was close to 200  $\mu\text{g}/\text{m}^2$ , belonging to a jacket from an “older” production batch (presumably manufactured before 2011) and a working gear jacket.

During this study, for each jacket two samples for the different extraction methods, namely the developed PFAS-a, PFAS-n and PFAS-f methods were prepared and analyzed. The application of  $^2\text{H}$ ,  $^{13}\text{C}$  and  $^{18}\text{O}$  labelled internal standards was very important during the analysis. Since all the analyzed jackets were consisting of different materials, colours, number and kind of layers, these factors were heavily influencing the “matrix effects” during the LC-MS/MS analysis. The extracted constituent parts of the matrix have an important influence, both in the chromatographic separation and the MS/MS analysis. As shown before, application of internal standards mostly compensated these matrix effects (see chapter 4.3.3).

Even a jacket having a label of fluorine-free impregnation showed a concentration of 20  $\text{ng}/\text{m}^2$  PFOA. Three samples from the lower backside of the jacket were analyzed and each sample measured for PFOA. The use of PFOA-containing substances as repellent agent during the finishing of the textile cannot be ruled out considering this result. A contamination during the production is possible as well. Due to the analysis the label of this jacket can be declared false.

Total PFAS concentrations in the jackets analyzed were determined in a range from 0.03  $\mu\text{g}/\text{m}^2$  to 136  $\mu\text{g}/\text{m}^2$ . PFASs were also detected and quantified in a fluorine-free labelled jacket as well. PFOA was found in each jacket in a concentration range of 0.02  $\mu\text{g}/\text{m}^2$  to 4.49  $\mu\text{g}/\text{m}^2$  and PFOS only in five jackets in a range of 0.01  $\mu\text{g}/\text{m}^2$  to 0.05  $\mu\text{g}/\text{m}^2$ . A variety of protection applications were implemented in the determination methods to prevent the analysis from contaminations.

Despite several protection activities the concentration of PFHpA was very high in all experiments and in the determination results as well. All the results showed only the concentration of extractable PFASs and cannot exhibit the whole concentration. The covalently bound polymeric PFASs moieties are assumed not to be measurable by this approach, because they cannot be extracted by the used extraction methods. The volatile properties of FTOHs

could be shown in this study and the evaporation of extractable FTOHs from textiles into the air has to be analyzed in further works.

According to the EPA-Stewardship-Program of the main side-chain fluorinated polymeric PFASs producers, a PFOA reduction of 100% is envisaged until the year 2015 (compared to the year 2000) (USEPA, 2013). Several producers of outdoor jackets have also announced this ambiguous goal in the meantime on their individual company websites. In general the C<sub>8</sub> perfluorinated PFASs moieties should be replaced by perfluorinated C<sub>6</sub> and C<sub>4</sub> alkyl chains (chapter 3.3.5.).

However, this trend could not be confirmed in the present study, since PFASs based on perfluorinated C<sub>8</sub> chemistry were the predominant species. Contrarily to the single PTFE-based (Gore-Tex<sup>®</sup>) jacket measured by Berger et al. (2006), in the present study a significant difference between the PFASs concentrations stemming from either PTFE or e.g. polyester membranes could not be observed.

Figure 13. Comparison of detected PFASs concentrations and ratios in DWR jackets; top: full scale, bottom: cut-out.

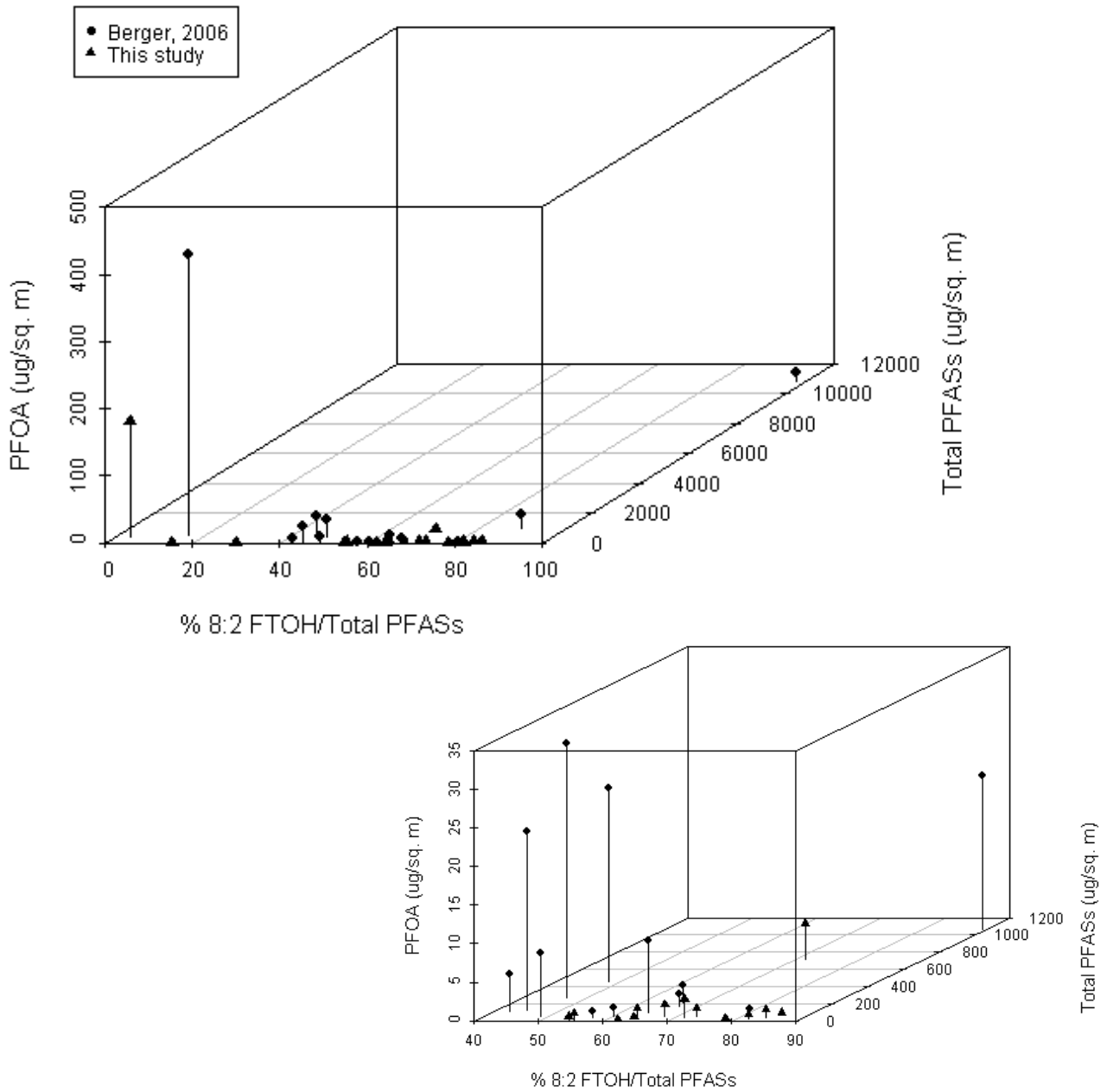

## 5 Analysis of impregnating agents

As mentioned in chapter 3.2, DWR jackets showing reduced or no repellency of the outer fabric, may be treated with impregnating agents in order to reconstitute their repellency, mainly against water. The impregnating procedure is generally performed by the jacket owners at home. Such treated jackets will have again the feature of repellency; however the original water column will in most cases not be reached anymore (information of repellent producer). Since it has been described, that the active compound of impregnating agents are most likely PFASs, the chemical constitution of the non-polymeric PFASs contained in such sprays as well as wash-in detergents was investigated too, since both, impregnating agents and such treated textile might also be a source for PFASs.

### 5.1 Materials and methods

#### 5.1.1 Selection of impregnating agents

A literature survey regarding the analysis of impregnation sprays on PFASs has been conducted, which are summarized in Table 37. For this study, three different impregnation sprays as well as two impregnating washing detergents have been investigated. The selection and purchase of these impregnating agents should have been based on different impregnating technologies, e.g. fluorocarbon- or silicon-based, in order to provide an overview of PFAS contamination in different kinds of impregnating agents. However, since such information was not possible to be retrieved, a selection of different brands being offered in outdoor stores was acquired.

#### 5.1.2 Analytical methods

The impregnating agents were investigated in consideration of the same cocktail of analytes as for outdoor jackets (see Table 12). HPLC-MS/MS methods and calibration curves were the same as for outdoor jackets as well (see chapter 4.2.1 and 4.2.2). The validation was performed as described below.

For PFAS-n, the sample preparation was carried out by subsequent dilution of the sample with methanol and addition of the internal standard M-8:2-FTOH. Dilution for different samples was between 1:1 and 1:100 using methanol. The resulting recoveries for the internal standard M-8:2-FTOH were between 79 and 137% and are shown in Figure 24 in the supplement information. These methods were sufficient for the quantification of FTOH's, if present in the investigated samples.

According to the PFAS-n-method, also PFAAs as well as FOSA derivatives were firstly analyzed without enrichment, but different dilution steps instead.

Since during the method development none of the analytes was detected under these conditions according to relatively high LODs, an enrichment procedure had to be developed. Thus, either 10 µL or 100 µL of the original samples were weighed and dissolved in 1 mL MeOH. A cocktail of internal standards was added as described in chapter 4.2.3 and the solution enriched by mixed-mode weak anion exchange SPE as explained in chapter 6.1.3. The recoveries were in the range of 71 and 128%; LODs as shown in Table 21 were in an acceptable range.



## 5.2 Results

In two of the investigated impregnating agents (I2 and I3) none of the investigated non-polymeric PFASs could be detected, whereas in I5 only low concentrations of PFOA (0.26 µg/mL) and 8:2-FTOH (0.23 µg/mL) were quantified (Table 21). However, it is not known if these agents are based on fluorine chemistry.

In the investigated samples of I4 and I1, the FTOHs were the predominant PFASs with maximum concentrations for 6:2-FTOH of 16.4 and 225 µg/mL, respectively. Additionally minor PFCA concentrations were measured within these samples with sum concentrations of PFASs below 0.5 µg/mL. Table 21 lists the individual PFASs concentrations determined in impregnating agents.

In none of the investigated impregnating agents PFASs, FOSA- and FOSE-derivatives could be detected. Method blanks were below LODs for all substances except for PFHpA, which was therefore excluded from the results.

Table 21. Concentrations determined in impregnation agents (in µg/mL); n.d. = not detected.

	I1	I2	I3	I4	I5	LOD
PFBA	0.17	n.d.	n.d.	0.02	n.d.	0.005
PFPeA	0.05	n.d.	n.d.	< 0.005	n.d.	0.005
PFHxA	0.13	n.d.	n.d.	0.01	n.d.	0.001
PFOA	n.d.	n.d.	n.d.	n.d.	0.26	0.001
PFNA	n.d.	n.d.	n.d.	n.d.	n.d.	0.0005
PFDA	n.d.	n.d.	n.d.	n.d.	< 0.005	0.005
PFUnA	n.d.	n.d.	n.d.	n.d.	n.d.	0.01
PFDoA	n.d.	n.d.	n.d.	n.d.	n.d.	0.005
PFTTrA	n.d.	n.d.	n.d.	n.d.	n.d.	0.001
PFTeA	n.d.	n.d.	n.d.	n.d.	n.d.	0.005
PFBS	n.d.	n.d.	n.d.	n.d.	n.d.	0.001
PFHxS	n.d.	n.d.	n.d.	n.d.	n.d.	0.0005
PFHpS	n.d.	n.d.	n.d.	n.d.	n.d.	0.005
PFOS	n.d.	n.d.	n.d.	n.d.	n.d.	0.001
PFDS	n.d.	n.d.	n.d.	n.d.	n.d.	0.005
6:2-FTOH	225	n.d.	n.d.	16.4	n.d.	0.01
8:2-FTOH	0.05	n.d.	n.d.	0.13	0.23	0.02
10:2-FTOH	< 0.004	n.d.	n.d.	0.04	n.d.	0.02
FOSA	n.d.	n.d.	n.d.	n.d.	n.d.	0.001
N-MeFOSA	n.d.	n.d.	n.d.	n.d.	n.d.	0.010
N-EtFOSA	n.d.	n.d.	n.d.	n.d.	n.d.	0.005
N-MeFOSE	n.d.	n.d.	n.d.	n.d.	n.d.	0.0005
N-EtFOSE	n.d.	n.d.	n.d.	n.d.	n.d.	0.0005

Analysis of the impregnating washing detergents unfortunately could not be performed, due to the matrix effects of the surfactants being present. Direct analysis of the detergents after dilution with solvent did not yield detectable PFASs concentrations. Enrichment via mixed-mode weak anion exchange SPE yielded very low (<5%) recovery of the internal standards, which is probably caused by competition of the binding sites in the SPE material with non-fluorinated anionic surfactants. The content of these surfactants probably exceed those of PFASs by far and thus inhibit the ionic interactions between the SPE material and the PFASs.

### 5.3 Discussion

Compared to the analytical data published so far (see Table 37) in the supplement information) the detected 8:2-FTOH-concentrations were quite low, even negligible. As it can be seen in Figure 14, the 8:2-FTOH share of all investigated non-polymeric PFASs in the studies performed between the years 2007-2012, was always above 60%; maximum PFAS concentrations could even reach up to almost 1 mg/mL. However, the analyses performed within this study, the results were quite different. The two impregnating agents containing relevant PFASs concentrations (I1 and I4) almost exclusively showed 6:2-FTOH. Compared to the individual data from the outdoor jacket analyses, the ratio between 6:2-, 8:2- and 10:2-FTOH is significantly different. The predominance of 6:2-FTOH present in I1 and I4 indicates that here the substitution of C<sub>8</sub>-PFASs by C<sub>6</sub>-PFASs has already been performed (Figure 14). Besides the analyses of the non-polymeric PFASs it would have been of interest to additionally qualify the polymeric PFASs, which should be present in these samples. However, this was not the task of this study as well as methods for these analytes in such difficult matrices do not exist at present.

Figure 14. Summary of analytical results obtained for impregnating sprays and comparison to results previously determined; top: full scale, bottom: cut-out

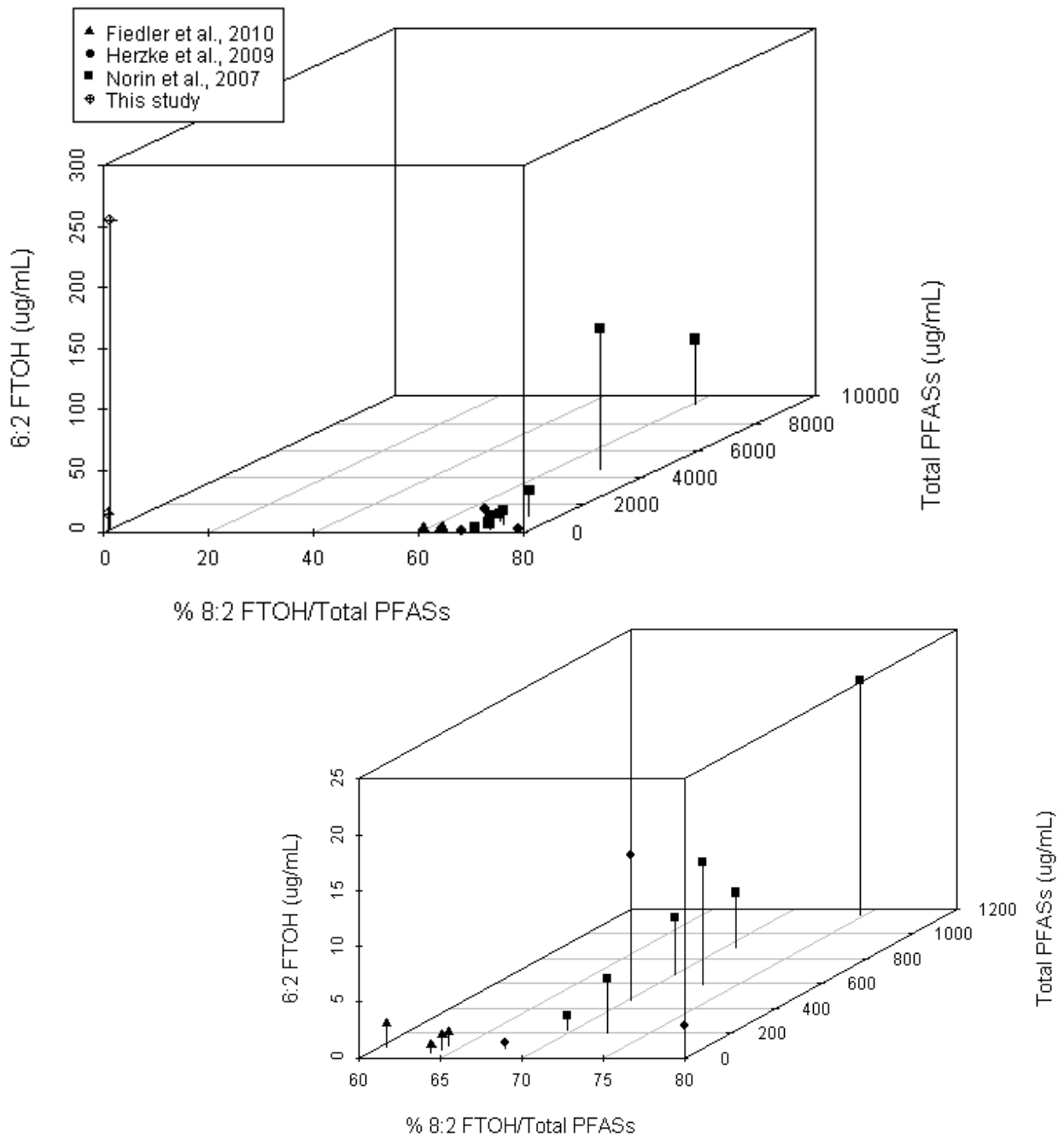

## 6 Emissions of PFASs during wearing and cleaning of outdoor jackets: evaporation studies and washing experiments

### 6.1 Materials and methods

#### 6.1.1 General information

In addition to determination of PFASs contents in outdoor jackets and in impregnating agents, the environmental impact of these products was investigated as well. Two processes were simulated: Wearing and storage of the jacket was simulated by an evaporation study in order to evaluate the volatilization of PFASs and washing was simulated by subjecting pieces of the previously analyzed jackets to a washing machine, whose effluent was recovered and analyzed for dissolved PFASs.

Additionally, the environmental impact of impregnating agents after usage was evaluated by impregnating textile pieces and carrying out the evaporation experiment and the washing experiment with this impregnating textile piece.

The same 24 PFASs and 10 mass labeled internal standards were investigated (Table 12) in the washing experiment, whereas only the neutral compounds (6:2-, 8:2-, and 10:2-FTOH, N-MeFOSE and N-EtFOSE) were analyzed in the emission experiments because the acidic PFASs were not expected to be volatilized since they exhibit low vapor pressures in their anionic form. For instance, APFO has a vapor pressure of 0.003 Pa at 25°C (Barton et al., 2009). Relevant compound data and structures are given in Table 12 and Table 13.

MeOH (Merck, Darmstadt, Germany), MilliQ water (in-house production) and the internal standards (in MeOH, Wellington Laboratories, Canada) were used for the extraction of the samples. All other solvents used were of the highest purity available (Merck, Darmstadt, Germany).

#### 6.1.2 Evaporation studies

In order to simulate PFASs emissions from wearing and storage of DWR jackets, a flow-through system was designed, where evaporated substances are trapped on reversed-phase solid-phase cartridges (Figure 15). For this experiment, those four of the jackets were chosen (J2, J8, J10, J15) which had shown notable amounts of volatile FTOHs (see Table 20).

An air pump (Marina Durchlüfterpumpe 100, OBI GmbH, Germany) was connected to a 2 L Schott bottle via a GLS80 connection system (Duran Group, Germany) with a 3 mm stainless steel HPLC tube. A piece of jacket was inserted on a flexible steel holder. For each jacket, a defined area of garment was used (see Table 22). As an exit tube, another 3 mm ID HPLC tube was used. A constant flow of air was pumped through the system which was connected to two Bond Elut C-18, 200 mg SPE cartridges (Agilent technologies, Waghäusel, Germany) mounted in series. 40 ng of the internal standard (M-8:2-FTOH in MeOH) was added directly onto the cut jacket piece in the flask. For the second cartridge, 40 ng of internal standard was added to the SPE eluate after extraction since the first 40 ng were completely trapped on the first SPE cartridge.

The first set of experiments with cut pieces of the four jackets was run for five days (see Table 22) and was extended by an additional two-day experiment for two out of four jackets in order to verify if the release of FTOHs has been completed.

Figure 15. Schematic experimental design of used for evaporation studies

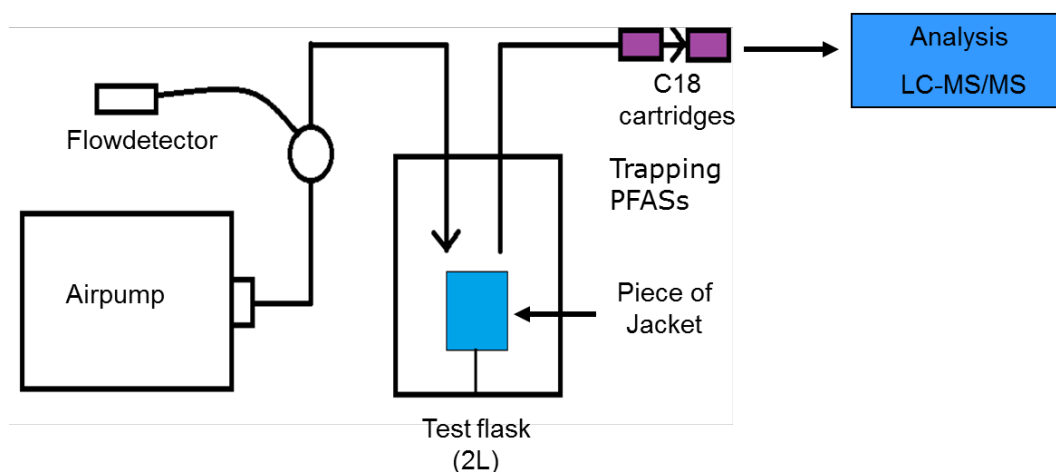

Before starting the evaporation period the cartridges were conditioned using 2 mL of methanol and dried under a gentle flow of nitrogen. For J2 and J8, they were changed after 5 days (see Table 22) and eluted with 2 mL of MeOH prior to analysis.

Table 22. Experimental setup of evaporation studies performed with the pieces of jackets J2, J8, J10 and J14.

Jacket	Area (m <sup>2</sup> )	Weight (kg)	Time (days)
J2	0.020	0.21·10 <sup>-2</sup>	5 + 2
J8	0.020	0.51·10 <sup>-2</sup>	5 + 2
J10	0.010	0.20·10 <sup>-2</sup>	5
J14	0.005	0.79·10 <sup>-3</sup>	5

Evaporation studies were performed in duplicate and the resulting samples were injected once. Eluates of the two SPE cartridges were analyzed separately. For each separate experiment, one blank sample was prepared using an empty flask which was spiked with 40 ng internal standard (PFAS-n mix) divided over five days.

For the additionally performed experiments with freshly impregnated outdoor jackets, two of three equally cut pieces of jacket J2 were impregnated with impregnating agent I1. The impregnation was performed by adding a dissolved solution as described in chapter 6.1.4. A total of four evaporation systems were run in parallel. Two systems were used for simulating the evaporation of volatile PFASs from the freshly impregnated textile pieces. The one piece which was not impregnated served as a field blank, whereas an empty flask that was operated simultaneously served as a method blank.

### 6.1.3 Washing experiments

In order to simulate PFASs emissions from washing of DWR jackets, washing experiments were performed using an easycare program (reduced spinning, temperature 30°C) with four selected jacket pieces at once, showing notable PFAA concentrations (J2, J8, J10, J14). No detergent was used in this experiment in order to allow for enrichment of PFAAs by SPE. As explained in chapter 5.2, anionic detergents negatively influence the recovery of PFAAs by competition for binding sites in the SPE material. Tests including detergent were carried out but showed extremely low recoveries (< 5%) of PFAAs (data not shown).

The drain of a washing machine was connected to a 60 L container to collect all washing water. Three 500 mL aliquots of the thoroughly mixed washing water were spiked with 1 ng internal standard mixture (PFAS-a mix) as well as 10 ng M-8:2-FTOH and extracted using Oasis WAX 60 mg SPE cartridges (Waters) with a vacuum manifold at a rate of approximately two drops per second. SPE cartridges were preconditioned using 2 mL MeOH containing 0.1% NH<sub>3</sub>, 2 x 2 mL MeOH, and 3 x 3 mL H<sub>2</sub>O. After loading, the cartridges were washed with 3 mL of a H<sub>2</sub>O/MeOH (80:20; V:V) mixture and dried for 10 minutes under nitrogen. The FTOHs, FOSAs and FOSEs were eluted with 2 x 1.5 mL MeOH containing 0.05% acetic acid. PFAAs were eluted with 2 x 2 mL MeOH containing 0.1% NH<sub>3</sub> and were evaporated to dryness. 500 µL of 50:50 H<sub>2</sub>O/MeOH was added and the resulting mixture was filtered through a cellulose syringe filter (Spartan, 0.45 µm).

A second washing was performed with the already washed jacket pieces. The same sampling procedure was used as described in the beginning of this chapter.

#### 6.1.4 Impregnating agents

One impregnating agent (I1) was used to simulate PFASs emissions from these products in washing water and in the air. For the air sampling, the same setup has been used as described previously. In order to have a measurable concentration range, no break-through of the used cartridges and coverage of the cut J2 textile piece, the latter was sprayed with 100 µL of a 100-fold diluted impregnating agent solution (in MeOH) and was put in the flow-through system for 16 h. Afterwards, the SPE cartridges were eluted with 2 mL MeOH prior to LC-MS/MS analysis.

An additional piece of J2 was treated with 10 mL of the impregnating agent and washed as described in chapter 6.1.3. Three times 200 mL of the washing water was spiked with 60 ng M-8:2-FTOH and 0.5 ng PFAS-a internal standard mixture. The Oasis WAX 60 mg SPE cartridges were conditioned and eluted as described in chapter 6.1.3.

#### 6.1.5 Instrumental method

The instrumental setup for the HPLC-MS/MS analyses has already been described in chapter 4.2.1 and 4.2.2.

## 6.2 Quality control

### 6.2.1 Evaporation studies

Prior to the analysis of the jackets, experiments were performed using empty flasks spiked with a known amount of analytes for the validation of the flow-through system. After a period of 15 hours, the SPE cartridges were eluted and internal standard (M-8:2-FTOH, 120 ng) was added. This resulted in a recovery of 71% for 6:2-FTOH, 87% for 8:2-FTOH, and 88% for 10:2-FTOH. In all samples, an additional amount of 100 ng of the analytes was spiked in the eluates to determine recovery of the analytes on the SPE material (supplement information, Table 45). LOQs were calculated using a signal to noise ratio of 10. The LOQs ranged from 0.28 ng for N-EtFOSE to 15.7 ng for 6:2-FTOH (Table 23) and refer to the absolute amount in the flask.

Table 23. LOQ and LOD for neutral PFASs for evaporation studies.

	LOQ (ng)	LOD (ng)
6:2 FTOH	15.7	5.2

8:2 FTOH	9.0	3.0
10:2 FTOH	6.9	2.3
N-MeFOSE	0.40	0.14
N-EtFOSE	0.28	0.10

Quantification of all samples was performed with a linear 8-point calibration curve (with  $R^2 > 0.98$ ). The concentrations ranged from 10 µg/L up to 200 µg/L.

### 6.2.2 Washing experiments

Washing of the jackets (with and without the impregnating agent) was performed in duplicate and the resulting washing water was extracted in triplicate. MilliQ water with addition of the internal standard-mix was used as a method blank and was extracted in triplicate. Washing water without addition of the jackets was used as a background blank. PFASs were quantified as described in 6.1.3. Additionally, a two ng PFAS-a mix was spiked into the washing water blank in order to determine recovery rates.

The area of the different analytes and internal standard was compared with a 12-point calibration curve. LOQs in the washing water were calculated using a signal to noise ratio of 10. The LOQs and LODs can be found in the supplement information (Table 48).

Quantification of all samples was performed with a linear 8-point calibration curve for the neutral compounds (with  $R^2 > 0.99$ ) and a 12-point calibration curve for the acidic compounds (with  $R^2 > 0.98$ ). The concentrations ranged from 10 µg/L up to 200 µg/L for the neutral compounds and from 0.05 µg/L up to 40 µg/L for the acidic compounds.

## 6.3 Results and discussion

### 6.3.1 Evaporation studies

Several flow-through studies were conducted in August, September and October 2012 (Table 22). From the analyzed PFASs not all analytes were detected in the air samples (Table 25). N-EtFOSE was detected only once in the air sample from the J14 at a concentration  $< LOQ$ , and is therefore not shown in Table 25. Blanks were subtracted from the data (see Table 24), but were generally very low compared to the FTOH concentrations.

The whole array of individual data can be found in Table 46 and Table 47 in the supporting information.



Table 24: Average blank values in methanolic eluates from cartridges used for flow-through studies of volatile PFASs

Substance	Average Blank [ng/mL eluate]
6:2 FTOH	0
8:2 FTOH	1.70
10:2 FTOH	1.23
N-MeFOSE	0.565
N-EtFOSE	0.527

6:2-FTOH was only found in air samples from jackets 2 and 8 with concentrations ranging from <LOQ to 0.71 µg/m<sup>2</sup>. This was supported by solvent extraction of the textiles, which showed 6:2-FTOH was only present in one of the sampled jackets (Table 20). 8:2-FTOH and 10:2-FTOH were found in all air samples. Concentrations ranged from 3.46 µg/m<sup>2</sup> up to 90.6 µg/m<sup>2</sup> for 8:2-FTOH and from 2.74 µg/m<sup>2</sup> up to 110 µg/m<sup>2</sup> for 10:2-FTOH after a 5-day flow through study.

Concentrations were expressed as microgram per square meter of jacket. The highest neutral PFASs air concentrations were found in J14. This jacket also showed highest concentrations after extraction of the textile.

After the 5-day flow through study, two jackets (J2 and J8) were measured for an extra period of two days. Results of these experiments can be found in Table 26. It can be seen that the jackets still emit FTOHs, with the highest amounts for 10:2-FTOH. Concentrations for this compound range from 0.42 µg/m<sup>2</sup> up to 1.43 µg/m<sup>2</sup>.

Table 25. Airborne concentrations of neutral PFASs from DWR jackets after a 5-day evaporation study expressed as µg substance per kg jacket.

Jacket	6:2-FTOH (µg/kg)	8:2-FTOH (µg/kg)	10:2-FTOH(µg/kg)
J2	6.37 (3.37)	32.8 (0.63)	54.0 (1.95)
J8	<LOQ	22.9 (1.61)	31.2 (1.44)
J10	n.d.	21.5 (0.25)	13.8 (2.18)
J14	n.d.	534 (40.3)	623 (38.7)
	6:2-FTOH (↔g/m <sup>2</sup> )	8:2-FTOH (↔g/m <sup>2</sup> )	10:2-FTOH(↔g/m <sup>2</sup> )
J2	0.71 (0.32)	3.46 (0.25)	5.69 (0.11)
J8	<LOQ	5.83 (0.66)	7.95 (0.70)
J10	n.d.	4.26 (0.28)	2.74 (0.28)
J14	n.d.	90.6 (15.8)	110 (23.8)

All concentrations are given in ↔g/kg and ↔g/m<sup>2</sup> of jacket. SD is given between brackets [n=2].

Table 26. Airborne concentrations of neutral PFASs from outdoor jackets after an additional 2-day evaporation study.

Jacket	6:2-FTOH ( $\mu\text{g}/\text{m}^2$ )	8:2-FTOH ( $\mu\text{g}/\text{m}^2$ )	10:2-FTOH( $\mu\text{g}/\text{m}^2$ )
J2	0.26 (0.37)	0.08 (0.07)	0.42 (0.02)
J8	<LOQ	0.26 (0.32)	1.43 (0.35)

All concentrations are given in  $\mu\text{g}/\text{m}^2$ . SD is given between brackets [n=2].

Measured concentrations were compared with extraction data (see Table 20) in order to calculate the release. The relative release gives the ratio between the amount which was emitted in the air during the experiments and the total amount measured after solvent extraction of the jacket. Figure 16 shows a clear difference in release between the measured compounds. The release for 6:2-FTOH only showed quantifiable results for one jacket (J2). The releases for 8:2-FTOH range from 6.5% up to 18%. J8 and J14 showed the highest releases for 8:2-FTOH, followed by J2 and J10 respectively. Standard deviations were relatively small, due to the higher concentrations measured for this compound. Releases for 10:2-FTOH showed almost the same order as 8:2-FTOH, with the highest release for J8. Releases for 10:2-FTOH ranged from 27% up to 70%. Standard deviations were 4-fold higher than those for 8:2-FTOH. N-MeFOSE and N-EtFOSE were not present in the jackets and were therefore not found in the air samples.

Releases were highest for the two jackets which contain PTFE membranes (see Table 11). However this observation might not be generally valid due to the limited number of jackets tested during this experiment.

Figure 16. Percentage release of FTOHs from DWR jackets to the air. Percentage released was calculated by dividing the amount of substance volatilized by the amount determined by solvent extraction (based on  $\mu\text{g}/\text{m}^2$  data); error bars show SD [n=2].

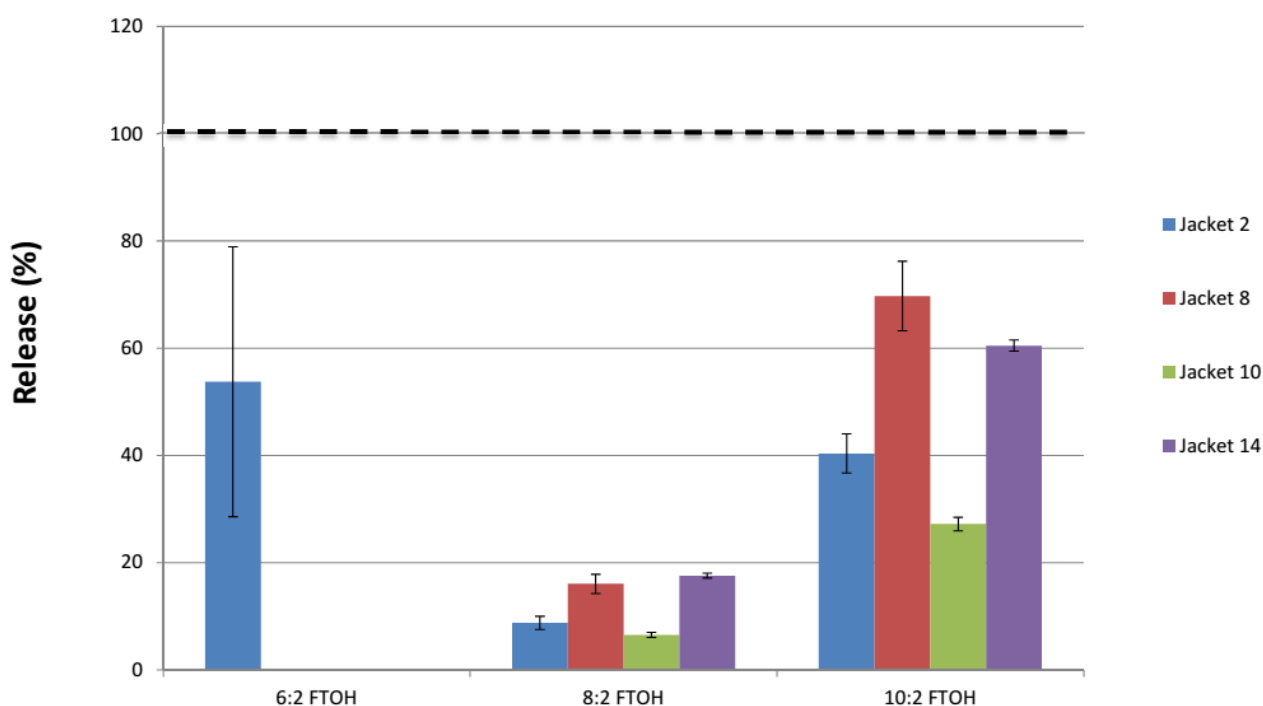

It has clearly been shown, that during the experiments being conducted, FTOHs stemming from the investigated jackets were released into the air.

Relative releases for 8:2-FTOH were substantially lower than releases for 10:2-FTOH (Table 27). It was expected that releases for 8:2-FTOH would be higher than those of 10:2-FTOH due to its higher vapor pressure (vapor pressure at 25 °C; 8:2-FTOH: 45.9 Pa, 10:2-FTOH: 13.3 Pa, Lei et al., 2004).

All jackets used for this study were purchased in the beginning of 2012. The solvent extraction data was obtained in February to March 2012, some months before the flow-through studies. Although the jackets were stored in a sealed plastic foil in the meantime, volatilization or migration of FTOHs into the foil cannot be utterly prevented. Thus, it could be possible that the short-chain compounds are already released to the atmosphere during this period. This would explain the difference between the relative releases of the FTOHs and will be further discussed in the outlook of this study.

Table 27. Percentage relative release of volatile PFASs from DWR jackets by evaporation.

Jacket	6:2-FTOH	8:2-FTOH	10:2-FTOH
J2	53.7 (24.0)	8.76 (0.64)	40.4 (0.75)
J8	-	16.0 (1.81)	69.7 (6.17)
J10	-	6.51 (0.43)	27.2 (2.81)
J14	-	17.6 (3.08)	60.5 (13.0)

Release is given in percentages and is based on the ratio between concentrations measured by solvent extraction of jackets and concentrations measured in the air ( $\leftrightarrow$ g/m<sup>3</sup>). SD is given between brackets [n=2].

### 6.3.2 Washing water

As described in chapter 6.1.3., two separate washing experiments were conducted using four different jacket pieces at once each time. A second washing experiment performed with the already once washed jacket pieces was deemed necessary in order to follow-up additional releases of PFAAs into the washing water. With these experiments, the summary load of the PFAAs stemming from the jackets to the washing water was calculated. Theoretically, a further series of washing experiments would have been needed in order to study the PFASs releases until no difference compared to the background levels would have been achieved. However, even if of interest, this had not been the goal of the performed experiments.

Due to the relatively high background concentrations in the washing water in comparison with the amount of individual PFASs introduced via the pieces of textiles (Table 28), it was not possible to calculate the release for all compounds. PFBA, PFPeA, PFHpA, PFDoA, and PFTrA could not be quantified for this reason. For the other compounds, total relative releases (in percentages) were calculated for both, the first and second washing of the pieces of DWR jackets and washing water blanks were subtracted from these results. Overall, releases during the second time washing were lower than releases during the first washing (see Figure 17)

Table 28: Blank concentrations of PFASs in washing water. Substances not mentioned were not detected.

Substance	Concentration [ng/L]
PFBA	0.66
PFPeA	1.03
PFHxA	1.59
PFHpA	2.19
PFOA	3.08
PFNA	0.05
PFDA	0.31
PFDoA	1.41
PFUnA	0.02
PFTeA	0.32

Figure 17. Percentage release PFASs from DWR jackets during washing. Releases were calculated by dividing the amount released by washing by the amount of solvent-extractable PFASs

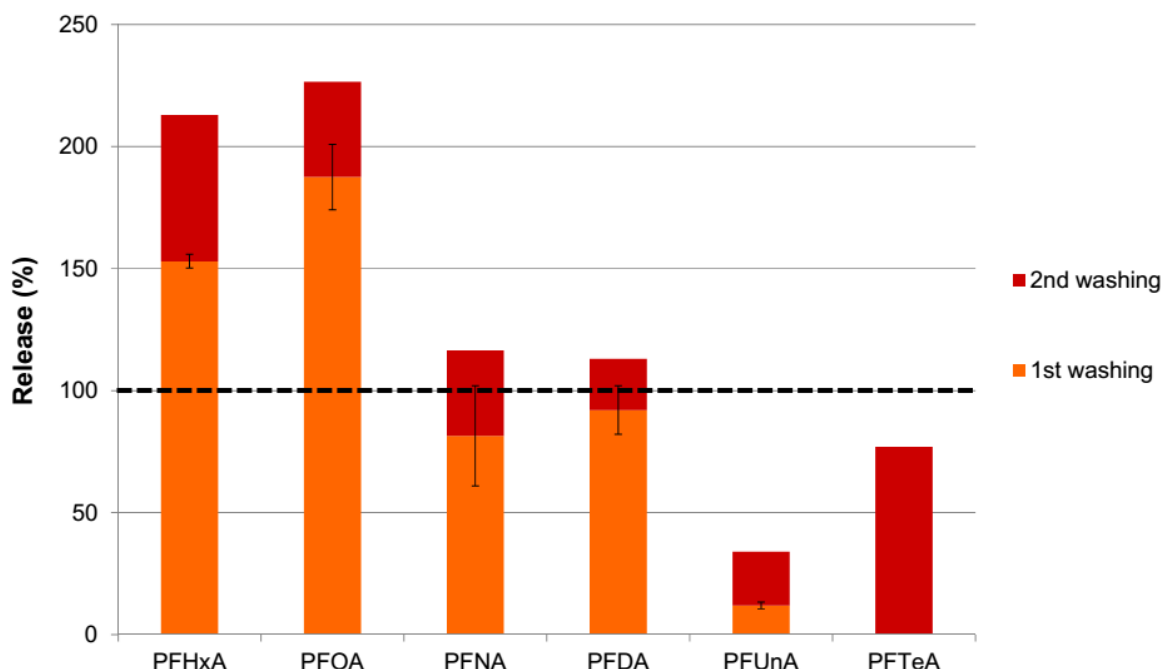

As can be seen from Table 29, release of PFCAs decreases with an increase in chain length. This is to be expected due to the lower solubility of higher chain length PFCAs.

The highest releases in sum can be found for PFOA and PFHxA, being just above 200% each. So far, no valid explanation has been found for these high releases. Quantification issues can be ruled out due to the application of individual internal standards for most of the compounds (see Table 16).

The results of the second washing of the jackets pieces show a decrease in the amount of PFCAs released during the repeated washing. Releases are up to a factor of five lower than in the first washing experiment except for PFUnA and PFTeA. PFUnA showed during both washing experiments almost equally releases of 20% each, which most likely results from the low water solubility. As mentioned above, it would have been of interest to conduct a series of further washing experiments in order to follow up how – and if – the measurable release would come to an end. The release of PFTeA, which was initially present in the washed jacket pieces at a very

low concentration, could only be quantified during the second washing. However, due to the low concentrations close to the LOQ, this value should only be treated in such a way, that even such non-polar analytes can be released into water.

But already from the results obtained after two washings, it seems that almost all extractable non-polymeric PFASs being monitored have been washed out. Thus washing – even without detergents – leads to release of water-soluble PFASs into the aquatic environment.

It is likely that there are other sources, e.g. precursors of PFOA and PFHxA in the system like the corresponding FTOHs. However, such a biological transformation as described by Wang et al. (Wang, 2005) is not supposed to occur in a washing machine and even if so, the transformation rate would be very high compared with literature data. Again, similarly to the discussed losses of volatile PFASs during storage, transformation processes might also have occurred during this period of time, lasting at least five months. However, since these processes were not anticipated during the planning of the experimental design, only speculations can be given. The authors recommend to conduct a series of additional experiments to study these hypotheses more systematically.

Table 29. Relative release of PFASs from DWR jackets J2, J8, J10 and J14 after washing. Releases are given in percentages and are based on the ratio between the expected amount of the compounds and the amount found in the washing water.

Compound	Release 1a (%)	Release 1b (%)	Release 2a (%)	Sum 1a & 2a (%)
PFBA	n.d.	n.d.	n.d.	n.d.
PFPeA	n.d.	n.d.	n.d.	n.d.
PFHxA	155	151	60	216
PFHpA	n.d.	n.d.	n.d.	n.d.
PFOA	197	178	39	235
PFNA	96	67	35	131
PFDA	99	85	21	119
PFUnA	13	11	22	35
PFDoA	n.d.	n.d.	n.d.	n.d.
PFTTrA	n.d.	n.d.	n.d.	n.d.
PFTeA	0	0	77	77

Experiment 1 was done in duplicate (1a and 1b), the second time washing with the same pieces of DWR jackets was denoted as experiment 2a. n.d. = not detected

### 6.3.3 Release of PFASs from jacket pieces treated with impregnating agents

Both, air release and washing water release experiments were conducted again after application of the impregnating agent I1 to selected jacket pieces. These experiments were carried out in order to investigate the potential of impregnating agents as additional source of PFASs entering the environment and stemming from the use of DWR jackets.

The evaporation study performed with the impregnated jacket pieces of J2 showed that 79% of the applied 225 ng total 6:2-FTOH being calculated in the applied amount of I1, was released

into the air. Since besides 6:2-FTOH, other neutral PFASs were negligible in the applied impregnation agent (see Table 20) consequently also no other neutral PFASs were detected.

As I1 belongs to the group of impregnating agents which have to be applied during washing, the following experiments were done in the washing machine. Four different pieces of jackets (J2, J8, J10, J14) were put in the washing machine with 10 mL of I1 being added to the washing water just shortly before starting the washing program. In order to reduce the PFASs background, the jacket pieces already been washed twice were used. Consequently with this experiment, the jacket pieces were now washed for the third time.

For calculation of the emission, the maximum theoretical input stemming from the individual jacket pieces determined by the initial extraction experiments, were used. This approach was chosen to have comparison between the theoretical maximum load of PFASs stemming from the jacket pieces and the release from the PFASs stemming from the impregnating agent.

Analysis of the washing water showed that none of the FTOHs were present in the water, which can be explained by their low water solubility.

PFOA, PFNA and PFDA, which were not detectable in the used impregnating agent I1 (Table 20) were quantified at much lower concentrations than calculated as maximum theoretical input stemming from the textile pieces. This again confirms the hypothesis that PFASs are washed out easily.

However, PFHxA and PFPeA were detected during this experiment in such high concentrations, that it cannot be explained by blank values, the calculated share from the jackets or the impregnating agent itself (Table 30). These high PFHxA and PFPeA concentrations can only be explained while suggesting another possible source.

There are various assumptions for these measurements. For example, it could be possible that some (approx. 1 %) of the 6:2-FTOH is transformed during the washing process to PFHxA, as discussed already above. Another explanation, which is favored by the authors of this report, would be the abiotic transformation of so far not monitored precursors of PFHxA and PFPeA during the washing process.

Currently, there is not any proof for these assumptions, but FTOHs and other precursors can be transformed to PFCAs by several processes (Wang, 2005, Wallington, 2006). This, however, was not the purpose of the present study and needs to be further investigated.

Table 30. Amount of PFASs released in washing water following the impregnation of jacket pieces with I1. The amount of PFASs is given in µg.

Compound	1) Amount in washing water (µg)	2) Theoretical max. input in washing water from jackets (µg)	3) Theoretical input in washing water from impregnating agents (µg)	1) corrected for 2) and 3) (µg)
PFBA	n.d.	0.022	1.67	n.d.
PFPeA	<b>7.63 (0.473)</b>	0.043	0.456	<b>7.13 (0.473)</b>
PFHxA	<b>33.8 (2.71)</b>	0.116	1.34	<b>32.3 (2.71)</b>
PFOA	0.306 (0.027)	0.717	-	-
PFNA	0.178 (0.029)	0.257	-	-
PFDA	0.140 (0.008)	0.430	-	-

SD (also in ng) is given between brackets. A deviation is made between the amount in washing water and the amount which could be stemming from the impregnating agents or the jackets themselves. The last column gives the amount of PFASs in the washing water which cannot be explained by both, the jackets and the impregnating agent. All values are corrected for the blank.



## 7 Environmental exposure

The environmental exposure to PFASs from outdoor jackets was estimated using German import and export numbers collected from the German Federal Statistical Office (see chapters 3.7 and 12.2). As already discussed thoroughly in this study, there are several uncertainties regarding the amount and type of jackets to be included in such calculations.

The environmental exposure to PFASs from outdoor jackets per country can be calculated using the following equation:

$$E = \frac{\omega_{jacket} * m_{jacket} * r * SN}{100}$$

where

E: Environmental load (kg)

$\omega_{jacket}$ : Average concentrations found in the jackets (kg/kg)

$m_{jacket}$ : Average mass of the jackets (kg)

r: Release in the different compartments of the environment (%)

SN: Amount of jackets sold per country, here Germany.

The amount of jackets provided by the German Federal Statistical Office give the total amount of jackets imported in Germany, thus not the total amount of jackets sold. The trade deficit of jackets, 88 million in the year 2011, includes any type of outdoor and rain jackets as well as anoraks. Neither quality nor price of the jackets, nor the fraction of jackets containing PFASs for repellency could be retrieved. Therefore different scenarios were adopted.

The first scenario is based on a ratio of 1:4 between jackets containing PFASs and such being non-DWR or DWR based on alternative technologies. Such a ratio of 25% would cope with the assumptions being made in other reports, as cited in chapter 3.4. In this case a total of 22 Million jackets per year would be considered to contribute to the PFASs burden estimated for Germany. Again, there is uncertainty as to whether jackets are washed already during the year of purchase and how much of the volatile PFASs have been emitted already during the production, transport and storage (see below).

A second scenario takes into account an additional safety factor of two, leading to a 1:1 ratio between PFASs-containing and non-containing jackets leading to a sum of 44 Million jackets.

The third scenario assumes the very unlikely worst case that all jackets imported in surplus into Germany, 88 million, are finished with PFASs or contain fabrics/membranes being made of polymeric PFASs.

Furthermore, it is assumed that 100% of the water soluble PFCAs (C<sub>4</sub> to C<sub>8</sub>) are introduced into the water cycle following a household washing and that all jackets are washed within the year of purchase.

These numbers resulting from these scenarios were multiplied with the average concentrations of PFASs found in the jackets and/or the determined emission data and compared with environmental PFASs concentrations having been reported in the literature so far.

N-MeFOSE and N-EtFOSE were not found in the air samples. It can thus be assumed that the load of these compounds in the air is negligible.

The flow-through studies showed an average release of 50% of 10:2-FTOH to the air and an average release of 12% for 8:2-FTOH. 13% of 6:2-FTOH was released to the air during the five day flow-through studies. With these values, total exposure to the air was calculated using several values for the in surplus imported jackets in Germany (see Table 31). The calculations resulted in a maximum environmental air load of 2.40 kg 10:2-FTOH according to the experimental results. The environmental air load for 8:2-FTOH was 1.90 kg for scenario 3 (see Table 31).

If the assumption is applied that 100% of the initially detected 8:2-FTOH and 90% of the 10:2-FTOH was released including the above discussed losses during storage, the total load increases significantly for the worst case scenario to e.g 15.5 kg 8:2-FTOH.

Table 31. Predicted environmental air load for the neutral PFASs. The environmental load was calculated using equation 1. Scenario 1 was based on a sales number of 22 million, scenario 2 used a sales number of 44 million, and scenario 3 used a sales number of 88 million DWR jackets.

	Release (%)	Load <sup>1</sup> (kg)	Load <sup>2</sup> (kg)	Load <sup>3</sup> (kg)
6:2-FTOH	13	0.01	0.02	0.04
8:2-FTOH	12	0.48	0.95	1.90
10:2-FTOH	50	0.60	1.20	2.40
8:2-FTOH <sup>4</sup>	100	3.89	7.77	15.5
10:2-FTOH <sup>4</sup>	90	1.09	2.19	4.37

<sup>1</sup> Scenario 1; <sup>2</sup> Scenario 2; <sup>3</sup> Scenario 3; <sup>4</sup> Scenario 4 including the assumed loss during storage.

However, if an initial concentration directly after the fabrication of 5 mg 8:2-FTOH per kg (roughly equal to one jacket) would be considered, as analyzed and expected for such light fabrics (The North Face, 2012), already scenario 1 would lead to an air emission of 110 kg and taking into account the acceptable amount of 50 mg/kg of Bluesign, this would sum up to above 1 t.

It is assumed that an annual emission of 100-1000 t per year of 8:2-FTOH is needed to maintain the observed atmospheric concentrations (Ellis et al., 2003). The environmental load from DWR jackets could, based on the worst case scenarios, contribute significantly to this.

The data of this report confirm that 8:2-FTOH was the most abundant compound in the textiles analyzed compared with other non-polymeric PFASs. This might explain the relatively high 8:2-FTOH concentrations in shops selling outdoor clothes (see Table 5).

It has to be taken into account that the previously published studies for air analysis made use of passive air samplers, whereas in the present study a flow-through system was used to obtain final concentrations. It is not known how these different experimental setups correlate. In the studies cited in Table 5 also no additional measurements regarding the potential source of FTOHs have been performed. Fraser et al. (2012) showed the correlation between neutral PFASs indoor air concentrations and the amount of PFASs in serum. Measured indoor air concentrations of 6:2-FTOH, 8:2-FTOH, and 10:2-FTOH ranged from <LOD up to 70.6 ng/m<sup>3</sup>. The general mean concentration of 8:2-FTOH was 9.9 ng/m<sup>3</sup>. A strong positive association between serum PFOA and the measured FTOHs could be made. Since the serum PFOA was also positively

correlated with the hours spent in the office per week, there might also be such a correlation between office hours in a shop selling DWR. However, as far as the literature studied within this report, such studies have not been performed so far.

The PFASs load in washing water was calculated using equation 1. The value for the release was taken from the washing experiments 1a and 2a. Again, 3 scenarios were taken into account due to the high uncertainty in the amount of sold jackets in Germany. For compounds which had a release higher than 100%, it was assumed that 100% of extractable PFASs were released during washing (Table 31).

The highest calculated PFCAs load from washing DWR jackets, with a maximum of 0.27 kg, results from PFOA.

Table 32. Predicted environmental washing water load for PFASs. The environmental load was calculated using equation 1.

Scenario 1 was based on a sales number of 22 million, scenario 2 on a sales number of 44 million, and scenario 3 a sales number of 88 million DWR jackets.

	Load <sup>1</sup> (kg)	Load <sup>2</sup> (kg)	Load <sup>3</sup> (kg)
6:2-FTOH	0.00	0.00	0.00
8:2-FTOH	0.03	0.05	0.10
10:2-FTOH	0.01	0.02	0.05
PFHxA	0.01	0.03	0.05
PFOA	0.07	0.13	0.27
PFNA	0.03	0.05	0.10
PFDA	0.04	0.08	0.17
PFUnA	0.00	0.01	0.02
PFTeA	0.00	0.01	0.02

<sup>1</sup> Scenario 1; <sup>2</sup> Scenario 2; <sup>3</sup> Scenario 3

According to Ahrens et al. (2009), PFASs concentrations of Elbe river water ranged from 7.6 to 26.4 ng/L, whereas PFASs concentrations of WWTP effluents were approximately 5–10 times higher (30.5–266.3 ng/L), indicating that WWTPs are potential sources of PFASs in the aquatic environment.

According to the RIWA reports from 2009 and 2010 (RIWA, 2009; RIWA, 2010), average PFOA concentrations measured in the River Rhine at Lobith, NL, were 4 ng/L. Based on 50 Million people living in the River Rhine catchment and a calculated water flow of 2300 m<sup>3</sup> per s (being equal to 72.5 x 10<sup>12</sup> L per year) a yearly PFOA transport of 290 kg could be calculated. For Germany with approximately 80 Million people this would sum up to a total PFOA input into rivers of about 464 kg. With this estimation industrial emissions have not being separately considered. Based on these assumptions, the contribution stemming from the washing of outdoor jackets to the annual load of a “hypothetic” German river catchment, would be approx. 0.05%.

Based on a concentration of 20 ng/L PFOA in WWTP effluents and an estimation of 5 x 10<sup>12</sup> L household wastewater (WW) per year for Germany (unpublished data by the authors), an

annual entry of 100 kg PFOA stemming from these WWs into the corresponding rivers would result.

The share of PFOA stemming from washing water would be about 0.25%. All other water soluble and non-volatile PFASs show lower loads compared to PFOA (see Table 32).

## 8 Extrapolation of PFOA amount imported into Germany via DWR jackets

The focus of this report is on production, use and environmental emission of selected non-polymeric PFASs (see Table 1) with focus on PFOA. However, since in the available literature there is often no clear information regarding the material used for textile production and no differentiation between polymeric and non-polymeric PFASs, the performed extrapolations within this report have a high degree of uncertainty. Also it is not known how much PFASs precursors contribute to changing levels of e.g. PFCAs in textiles during production, transport and storage. However, this issue has not been known prior to the studies performed within this report and should be considered in further studies. Additionally, production rates of those precursors are generally unknown. In summary, this contributes to uncertainties regarding import calculations.

The calculation for extrapolating the PFOA amount imported into Germany via outdoor jackets has been performed under the following assumptions:

Based on the data from the German Federal Statistical Office (Table 6), Germany had a trade deficit of approx. 60,000 t of jackets in the year 2011.

If, similarly to the Swiss studies (see chapter 3.4), 3.3% of these jackets (anoraks and windbreaker) being imported into Germany are treated with PFASs, this would result in 2,000 t treated textile. Considering a share of 25% treated jackets (see chapter 7) would result in a total of 15,000 t jackets and taking the calculated share with 12.3% DWR jackets of the inventory made by the authors of this report (Figure 6) would result in ca. 7,500 t.

Considering 2-5 g of fluoropolymers and side-chain fluorinated polymers per kg textile (see chapter 3.2) results - with 25% treated jackets - in a total PFASs amount of 30 - 75 t.

Assuming a content of 0.1% t (1%) non-polymeric PFASs as initial impurities of the polymeric PFASs (see Chapter 3.2), would result in 30 - 75 kg (300 - 750 kg) non-polymeric PFASs per year being imported into Germany via outdoor jackets

These assumptions are in the range with the numbers calculated e.g. by Schröder (2009) and in a similar range as estimated for other countries (see chapter 3.3.). They are also roughly in line with the predicted environmental PFASs concentrations estimated for the annual emission of such an amount of jackets used in Germany (chapter 7). Here already the worst-case assumptions taken for the FTOHs in “scenario 1“ would correlate with these data.

Calculating the average PFOA-concentration in  $\mu\text{g}/\text{kg}$  for 14 of the 16 investigated jackets within this study (except the working-gear jacket and the jacket from an older production batch) results in a value of 4.7  $\mu\text{g}/\text{kg}$ . Taking again the “scenario 1“ with 15,000 t jackets result in an import of 70 g PFOA (280 g if all imported jackets contain PFOA) per year for Germany.

However, as mentioned above, these estimations are quite vague and do not take into account the eventual additional formation of PFOA via precursors.

## 9 Modeling human exposure to per- and polyfluoroalkyl substances (PFASs) from outdoor clothing and impregnation sprays

### 9.1 Methods

The approach to estimate human exposure to PFASs from DWR outdoor clothing was based on the Scenario-Based Risk Assessment (SceBRA) model previously used by Trudel et al., (2008). DWR outdoor jackets can act as sources of exposure through direct contact with the consumer or through wear, abrasion or migration of PFASs to the indoor environment. Exposure pathways that were considered included inhalation of impregnation sprays, dermal uptake from using impregnation sprays, dermal uptake from wearing treated clothes, hand-to-mouth transfer from treated clothes, inhalation of indoor air and ingestion of indoor dust (see detailed description below). Quantification of exposure through direct contact with products used measurements of extractable concentrations of PFASs in treated clothing and literature which has previously been generated in this study (chapter 4.3.6). However, for inhalation of indoor air and ingestion of house dust measured concentrations in the indoor air and dust respectively were used to quantify the exposure (see detailed description below). Due to the availability of data, the compounds considered in this study were PFHxA, PFHpA, PFOA, PFNA, PFDA, PFUnDA, PFDODA, 6:2-FTOH, 8:2-FTOH and 10:2-FTOH.

#### 9.1.1 Exposure groups

The exposure to PFASs was estimated for the general population of adult background exposed Europeans that use treated clothing in their everyday life and workers in outdoor retail stores that may receive an elevated occupational exposure to PFASs from treated clothing. The same exposure pathways were considered for the two exposure groups; although some exposure pathways were parameterized differently to reflect behavioral differences in contact with outdoor clothing (see below).

#### 9.1.2 Model uncertainty

Many of the input parameters used to model human exposure from outdoor clothing are either uncertain or variable. To reflect the range of exposures resulting from variability and uncertainty in input parameters, a low, intermediate and high scenario was calculated for each exposure pathway and exposure group. Preferably, percentile values were used; the 5th percentile for the low scenario, the 50th percentile for the intermediate scenario and 95th percentile for the high scenario respectively. As a second priority, minimum, arithmetic mean and maximum values were used for the input parameters.

#### 9.1.3 Direct and Indirect exposure to PFCAs

The exposure to PFCAs and FTOHs was expressed as the internal exposure, which is the amount of chemical incorporated into the body by ingestion, inhalation or dermal absorption. Direct exposure is defined as the uptake of PFCAs via any of these routes whereas, indirect exposure was defined as the exposure to precursor compounds (FTOHs) which are metabolized in the body to form PFCAs, following the terminology of De Silva et al., (2006).

To derive body-internal doses of PFCAs from FTOHs, knowledge regarding the biotransformation yields is needed. In this study, it was assumed that elimination of the

metabolite (PFCAs) is much slower than the precursor compound (FTOHs) ( $t_{1/2}$  (metabolite) >>  $t_{1/2}$  (precursor)). Thus, the indirect exposure to PFCAs can be calculated by multiplying the internal exposure of the precursor compound with a biotransformation factor.

Biotransformation factors of FTOHs to PFCAs were parameterized using data from in vitro studies using rat, mouse, trout, and human hepatocytes (Nabb et al. 2007) and in vivo studies in rats (Fasano et al. 2009; Himmelstein et al., 2011). Biotransformation studies have identified PFOA and minor amounts of PFNA as metabolites of 8:2-FTOH (Martin et al., 2005, Fasano et al., 2006 and Nabb et al., 2007). Analogously, and it may be expected that the metabolism of 6:2-FTOH will produce PFHxA and PFHpA and 10:2-FTOH will produce PFDA and PFUnDA (Martin et al., 2005). Since quantitative biotransformation data are only available for the yield of PFOA from 8:2 FTOH these biotransformation factors were used for all PFCAs. Subsequently, the indirect exposure to PFOA and PFNA was calculated using the same biotransformation factor multiplied by the internal exposure to 8:2-FTOH. Biotransformation factors in the low-exposure, intermediate and high-exposure scenarios were set to 0.0002, 0.005 and 0.017, respectively, to reflect the uncertainty in metabolic rates reported from the different studies (Martin et al., 2005, Fasano et al., 2006; Nabb et al., 2007) was compiled.

#### 9.1.4 Exposure pathways

##### Dermal uptake from wearing of treated clothes

Studies on dermal absorption of PFASs are rare, but in one study sponsored by 3M it was clearly demonstrated that PFOS could be absorbed through the skin of rats exposed to authentic consumer products (Frauenhofer, 2004). Dermal uptake from outdoor clothes was modeled as a two-step process. In the first step, the chemical is transferred from the fabric into perspiration on the skin from where, in the second step, it is absorbed through the skin. The perspiration acts as a storage compartment, from where absorption can occur even after treated clothes have been taken off. The function as a storage compartment ends when the perspiration is washed off. The equation used to model the uptake ( $E_{dermal}$ ) of PFASs through the skin is as follows:

$$E_{dermal} = \frac{(C_{cl_{new}} * x_1 + C_{cl_{wash}} * x_2)}{m_{bw}} * t_{exp} * TF_{cl_{skin}} * A_{skin} * r_{uptake}$$

Where

$$x_1 = (f_{cl_{new}} * n_{wbw} * MF_{cl} + f_{impr} * n_{wbw} * MF_{impr})$$

$$x_2 = f_{cl_{wash}} * MF_{cl}$$

$C_{cl_{new}}$ : Concentration of compound in new clothes [ng/cm<sup>2</sup>]

$C_{cl_{wash}}$ : Concentration of compound in washed clothes [ng/cm<sup>2</sup>]

$f_{cl_{new}}$ : Frequency of wearing new clothes [d<sup>-1</sup>]

$f_{impr}$ : Frequency of impregnation sprays use [d<sup>-1</sup>]

$f_{cl_{wash}}$ : Frequency of wearing washed clothes [d/d]

$n_{wbw}$ : Number of days clothes are worn before washing [d]

$MF_{cl}$ : Market fraction of clothes treated with PFASs [unitless]



$MF_{impr}$ : Market fraction of impregnation sprays with PFASs [unitless]

$t_{exp}$ : Time before skin is washed [h]

$TF_{cl_{skin}}$ : Fraction of compound transferred from clothes to skin [unitless]

$A_{skin}$ : Body surface area in contact with clothes [ $cm^2$ ]

$m_{bw}$ : Body weight [kg]

$r_{uptake}$ : Uptake rate of compound through skin [ $h^{-1}$ ]

The concentrations of extractable PFASs in clothes ( $C_{cl_{new}}$ ) were derived from the analytical results presented in this study (chapter 4.3.6. and Table 20). As washing tests demonstrate that the majority of extractable PFCAs are removed efficiently from the jacket during machine washing (chapter 6.1.3.) and FTOHs evaporate quite rapidly from DWR jackets during usage see chapters (see chapter 6.1.2. and 6.3). Therefore  $C_{cl_{wash}}$  was set to zero for PFCAs and FTOHs.

To calculate the frequency of wearing DWR outdoor jackets ( $x_1$ ) several parameters including the frequency of impregnating clothes at home, the frequency of wearing new unwashed clothes ( $f_{cl_{new}}$ ) and the market share of clothes treated with impregnation sprays were used. The market share of jackets ( $MF_{cl}$ ) and impregnation sprays ( $MF_{impr}$ ) containing PFASs was derived from the data presented previously in this report (chapter 3.7 and 3.9). For the low scenario it was assumed that a new outfit is only bought once a year and impregnation of clothes at home was assumed to be performed 0.2 times a year (Westat 1987; USEPA 1997). In the intermediate scenario a new outfit was assumed to be bought 6 times per year and impregnation in the home occurred 0.4 times a year (Westat 1987; USEPA 1997). In the high scenario the frequency of buying new clothes was set to twice a month and impregnation was assumed to occur twice a year (USEPA 1997). Every second time clothes are bought or impregnated, they are worn before washing. New or newly impregnated jackets were assumed to be worn for 0, 9 and 52 days for the low, intermediate and high scenario respectively. Washed clothes were worn the remainder of the year.

The fraction of compounds transferred from fabric to skin ( $TF_{cl_{skin}}$ ) was derived from Mawn et al., (2005) who studied the fraction of PFOA that is extracted from clothes into sweat. After 6 hours in a sweat simulant the textile samples had lost approximately 60 to 95% of their extractable PFOA. The values for  $TF_{cl_{skin}}$  used in the low, intermediate and high scenario were set to 60, 77.5 and 95%, representing the low, intermediate and high values from the study by Mawn et al. (2005). The skin area in contact with treated clothes ( $A_{skin}$ ) comprises the whole body except the head and the feet and was derived from United States Environmental Protection Exposure Factors Handbook (USEPA 1997). The low, intermediate and high values for the skin area in contact with treated textiles were 13,355, 15,720 and 19,235  $cm^2$  respectively. The assumption of body surface in contact with DWR treated textiles probably represents and overestimation of the actual contact area since DWR jackets are typically worn as second or third layer without direct skin contact. The importance of this assumption is discussed further below.

The uptake of PFCAs and FTOHs via the skin ( $r_{uptake}$ ) was derived from a study by Fasano et al., (2005) who estimated the absorption of ammonium perfluorooctanoate through human skin. The absorption in this study was expressed as cumulative percentage of chemical absorbed over 48 hours (Fasano et al., 2005). Dividing the cumulative percentage by the duration of the test

leads to the percentage of chemical absorbed per hour ( $h^{-1}$ ). Body weight values ( $m_{bw}$ ) for the exposed groups were derived from European Expofacts (2006) statistics.

### Hand to mouth contact with treated clothing

In the hand-to-mouth exposure pathway, the hand works as a vector transporting the compounds from the clothes to the mouth according to the following equation:

$$E_{HTM} = \frac{(C_{cl_{new}} * x_1 + C_{cl_{wash}} * x_2)}{m_{bw}} * TF_{cl_{skin}} * TF_{skin_{saliva}} * f_{htm} * t_{exp_{clothes}} * A_{skin_{mouth}} * r_{uptake}$$

Where

$$x_1 = (f_{cl_{new}} * n_{wbw} * MF_{cl} + f_{impr} * n_{wbw} * MF_{impr})$$

$$x_2 = f_{cl_{wash}} * MF_{cl}$$

In addition to the parameters used in the exposure pathway for dermal uptake from outdoor clothes the following parameters were used.

$f_{htm}$ : Frequency of hand-to-mouth contact events [ $h^{-1}$ ]

$TF_{skin_{saliva}}$ : Fraction of compound transferred from skin to saliva [unitless]

$r_{uptake}$ : Uptake of compounds through the gastro intestinal tract [unitless]

$A_{skin_{mouth}}$ : Skin surface area in contact with mouth [ $cm^2$ ]

$t_{exp_{clothes}}$ : Time exposed to clothes [h]

Although the parameter  $TF_{cl_{skin}}$  has the same notation as in the dermal uptake from outdoor clothes, the values used are not the same. The values used here were set to 0.01, 0.01 and 0.025 in agreement with Wasburn et al., (2005). A study by Kissel et al., (1998) reported the transfer fractions of soil during hand-to-mouth contact of 0.1 and 0.16 when mouthing a finger and sucking a thumb respectively. In addition, the US EPA office of pesticide programs report a default value of 0.5 for the transfer from hand-to mouth of pesticides (COPCC 2003). To reflect the uncertainty in values for this parameter 0.1, 0.16 and 0.5 were used in the low, intermediate and high scenario. The number of hand-to-mouth events per hour was estimated to 1 in agreement with COPCC (2003). The skin surface area was assumed to be three finger tops, ranging from 14.2 to 19.5  $cm^2$  in agreement with Wormuth et al. (2006). As hand-to-mouth transfer is an active process exposure only occurs during waking hours. The time exposed to clothes was subsequently set to 12.25, 16 and 18.5 h/day in the low, intermediate and high scenario in agreement with USEPA (1997). Since people working in outdoor clothing stores have hand contact with new clothing during their working days, a different value was used for the frequency of being in contact with new clothing ( $f_{cl_{new}}$ ) for the occupationally exposed population. To reflect the variability in working hours, and contact with new clothes  $f_{cl_{new}}$  was set to 0.5, 0.71 and 0.9  $d^{-1}$  respectively for the low, intermediate and high exposure scenario.

The uptake of PFASs via the gastro intestinal tract ( $r_{uptake}$ ) was derived from controlled feeding experiments of PFOA and 8:2-FTOH in rat (Hundley et al., 2006; Fasano et al., 2006). For PFCAs the oral absorption efficiency was set to 0.66, 0.8 and 0.9 in the low, intermediate and high exposure scenario respectively (Hundley et al., 2006). For FTOHs the oral absorption efficiency was set to 0.27, 0.38 and 0.58 in the low, intermediate and high exposure scenario respectively (Fasano et al., 2006).

### Inhalation exposure to impregnation sprays

The pathway inhalation exposure to impregnation sprays was as a two-compartment model which distinguishes between near-field and far-field exposure. The consumer performing the spraying task is located in the near-field, representing the breathing zone, for the time of the spraying. The volume of the far-field corresponds to the volume of the room where the spraying takes place (Vernez et al., 2006). After the spraying activity ends, consumers continue to be exposed to the concentration of chemical in the far-field when staying in the same room. The following equation was used to model this pathway:

$$E_{inhal_{impreg}} = \frac{C_{imp} * f_{imp} * t_{imp} * r_{spray} * F_{resp} * V_{inhal} * MF_{imp}}{m_{bw}} * \left( \frac{t_{spray_{NF}}}{V_{NF}} + \frac{t_{spray_{FF}}}{V_{FF}} \right) * r_{uptake}$$

Where

$C_{imp}$ : Concentration of compound in impregnation sprays [ng/g]

$f_{imp}$ : Frequency of impregnation spray use [ $d^{-1}$ ]

$t_{imp}$ : Duration of impregnation spray use [min]

$r_{spray}$ : Spray emission rate [g/min]

$F_{resp}$ : Fraction of respirable spray droplets [unitless]

$V_{inhal}$ : Inhalation volume during spray use [ $m^3/h$ ]

$MF_{imp}$ : Market fraction of impregnation sprays containing PFASs [unitless]

$V_{NF}$ : Near-field volume around consumer [ $m^3$ ]

$V_{FF}$ : Far-field volume around consumer [ $m^3$ ]

$t_{spray_{NF}}$ : Time exposed to spray droplets, near-field [h]

$t_{spray_{FF}}$ : Time exposed to spray droplets, far-field [h]

$m_{bw}$ : Body weight [kg]

$r_{uptake}$ : Uptake rate of compound through the lungs [unitless]

The concentrations of PFCAs and FTOHs in impregnation sprays ( $C_{imp}$ ) were derived from measurement data provided by this study (Chapter 5.2). Frequency of impregnation spray use ( $f_{imp}$ ) was derived from a report from USEPA (1997) which provides data for the frequency of household solvent usage (repellent/protector sprays). The same report (USEPA 1997) also provides data for the duration of use of household products, including spraying of repellents/protectors. These values were used as the time exposed to spray droplets in the near-field ( $t_{spray_{NF}}$ ). The far-field time of exposure ( $t_{spray_{FF}}$ ) was also given by USEPA (1997) as the “time exposed after of household solvents”. The spray emission rate ( $r_{spray}$ ) was derived from Glensvig et al., (2008) and Eftig and van Veen (1998) who conducted experiments with impregnating clothes and spray paint respectively. As the spray that deposits on the textile surface is not available for inhalation it is necessary to know the amount of overspray from impregnation sprays which were derived from Vernez et al., (2006). Inhalation volumes ( $V_{inhal}$ ) during use of impregnation sprays were adapted from USEPA (1997) under the assumption that spraying involves a moderate degree of activity. The market fraction of impregnation sprays containing PFASs derived from the Swiss Federal Office of Public Health (BAG 2005). The near

volume of exposure ( $V_{NF}$ ) corresponds to the breathing zone whereas the far-field volume ( $V_{FF}$ ) is the size of an average room as described by Vernez et al., (2006).

### Dermal exposure to impregnation sprays

In addition to inhalation during spraying, deposition of impregnation spray aerosols may also result in an exposure through dermal uptake. The following equation was used to model this pathway:

$$E_{inhal_{impreg}} = \frac{C_{imp} * f_{imp} * t_{imp} * q_{spray} * t_{exp} * MF_{imp}}{m_{bw}} * r_{uptake}$$

Where

$C_{imp}$ : Concentration of compound in impregnation sprays [ng/g]

$f_{imp}$ : Frequency of impregnation spray use [ $d^{-1}$ ]

$t_{imp}$ : Duration of impregnation spray use [min]

$q_{spray}$ : Quantity of spray deposited on skin [g]

$t_{exp}$ : Time before skin is washed

$m_{bw}$ : Body weight [kg]

Eftig and van Veen (1998) estimate that a quantity of 1.5 g of spray paint will deposit on the skin during a spraying time of 15 min. This results in a deposition rate of 0.1 g/min. By multiplying this deposition rate with the time the spray is used (section “Inhalation exposure to impregnation sprays”) it is possible to estimate the quantity of spray deposited on skin (g).

### Inhalation of indoor air

DWR jackets can act as sources of PFCAs to the indoor environment via volatilization. To model the exposure from inhalation of indoor air the following equation was used:

$$E_{inhal_{indoor}} = \frac{C_{indoor_{air}} \sum_{i=1}^n (V_{inhal} * t_{act_i})}{m_{bw}} * r_{uptake}$$

Where

$C_{indoor_{air}}$ : Concentration of compound in indoor air [ng/ $m^3$ ]

$V_{inhal}$ : Activity dependent inhalation volume [ $m^3$ /min]

$t_{act_i}$ : Time spent on different activities [min]

$r_{uptake}$ : Absorption of compound through lungs [unitless]

$m_{bw}$ : Body weight [kg]

For the background exposure scenario, concentrations of PFCAs and FTOHs in indoor air were derived from Shoeib et al., (2011) who sampled indoor air from houses, offices and apartments. For the FTOHs in occupational air were derived from Langer et al., (2010) who sampled indoor air in outdoor retail shops. The intermediate concentrations of different FTOHs were a factor of 10 to 30 higher in outdoor shops (Langer et al., 2010) compared to the background levels in residential buildings (Shoeib et al., 2011). The volume of air inhaled indoors was calculated by summing up the time spent on different activities multiplied by the inhalation volumes of

different activities. Activity patterns for the European population were derived from Eurostat (2004). Inhalation studies of FTOHs and ammonium perfluorooctanoate demonstrate a very efficient uptake (Kennedy et al., 2004; Himmelstein et al., 2011). In this study the absorption efficiency was assumed to be 100%.

### Ingestion of house dust

House dust can contain PFCAs and FTOHs from wear and abrasion of DWR treated jackets. This exposure pathway is modeled using the following equation:

$$E_{dust_{indoor}} = \frac{C_{dust} * q_{dust} * F_{time_{indoor}}}{m_{bw}} * r_{uptake}$$

Where

$C_{dust}$ : Concentration of compound in house dust [ng/mg]

$q_{dust}$ : Quantity of dust ingested daily [mg/d]

$F_{time_{indoor}}$ : Fraction of time spent indoors [unitless]

$m_{bw}$ : Body weight [kg]

$r_{uptake}$ : Uptake of compounds through the gastro intestinal tract [unitless]

DWR jackets treated with fluorinated side chain polymers can release FTOHs and PFCAs to the indoor environment during their lifetime (Knepper et al., 2012). Concentrations of PFCAs and FTOHs in dust were derived from the study by Huber et al., (2011) who sampled indoor dust from houses, apartments and offices in Norway. As no measurements of FTOHs and PFCAs in indoor dust in outdoor retail stores no specific data set could be used for the occupational exposure group. The quantity of dust ingested ( $q_{dust}$ ) was derived from a study measuring trace element concentrations in feces (Davis and Mirick 2006). These values are however calculated for individuals that spend 24 hours indoors. Estimated dust ingestion rates were therefore corrected for the fraction of time spent indoors ( $F_{time_{indoor}}$ ) derived from EU activity patterns (Eurostat 2004).

### 9.1.5 Calculation of total exposure and comparison with dietary exposure

The total exposure related to DWR outdoor jackets was calculated by summing up the different exposure pathways according to the following equation:

$$E_{tot} = E_{dermal} + E_{HTM} + E_{inhal_{impreg}} + E_{dermal_{impreg}} + E_{inhal_{indoor}} + E_{dust_{indoor}}$$

The total exposure was calculated for all individual PFCAs and FTOH homologues. In order to estimate indirect exposure to PFCAs from metabolism of FTOHs, the total internal exposure of FTOH was multiplied by the biotransfer factors described above. To determine the relative importance of exposure from DWR jackets, the exposures estimated here were compared with average dietary intake estimates derived for the Swedish populations (Vestergren et al., 2012).

## 9.2 Results

Table 33 displays the direct exposures to PFCAs for background and occupationally exposed populations respectively. As 5<sup>th</sup> percentile concentrations for several PFCAs were below method detection limits in the exposure media (DWR jackets, impregnation sprays, indoor air and dust) for all homologues except PFOA the low exposure scenario could not be quantified. Overall, the

range of exposure to PFCAs was a factor 20-50 between the intermediate and high exposure scenario. The highest direct exposures were observed for PFOA and PFUnDA which primarily can be explained by the relatively high concentrations of these compounds in indoor dust samples (Huber et al., 2011). Compared to the background scenario, occupationally exposed workers received a slightly higher direct exposure to PFCAs in the high exposure scenario. However, intermediate exposures for background and occupationally exposure groups were identical. The subtle differences between background and occupational exposure can be explained from the fact that direct exposure such as hand-to mouth transfer from clothing were almost negligible for the total estimated exposure (see also Figure 18 and Figure 19). Since PFCAs have not been measured in dust or air samples from outdoor clothing shops, this model was not able to capture any differences in direct exposure to PFCAs for the occupational exposure group.

Table 33. Calculated consumer product exposure to PFCAs (ng kg<sup>-1</sup> day<sup>-1</sup>) from DWR jackets for background and occupationally exposed populations estimated with low-exposure, intermediate and high-exposure scenarios.

	Direct exposure to PFCAs (ng day <sup>-1</sup> kg <sup>-1</sup> )						
	PFHxA	PFHpA	PFOA	PFNA	PFDA	PFUnDA	PFDoDA
	Background exposure						
Low	0.00	0.00	0.01	0.00	0.00	0.00	0.00
Intermediate	0.01	0.01	0.05	0.03	0.02	0.04	0.003
High	0.76	0.67	1.89	0.97	0.42	1.75	0.11
	Occupational exposure						
Low	0.00	0.00	0.01	0.00	0.00	0.00	0.00
Intermediate	0.01	0.01	0.05	0.03	0.02	0.04	0.003
High	0.78	0.86	1.93	1.08	0.45	1.85	0.12

The estimated exposure to FTOHs (Table 33) for background exposed populations was approximately 20 times higher compared to the direct exposure to PFCAs. Furthermore, the occupational exposure group received a significantly higher exposure to FTOHs (factor 5-15) compared to the background exposed population for both the intermediate and high exposure scenarios. The higher exposure to FTOHs for the occupational exposure group reflects the high indoor air concentrations in outdoor clothing shops (Lange et al., 2010) that workers are exposed to. The intermediate indirect exposure to PFCAs resulting from uptake and metabolism of precursor compounds (Table 34) was a factor 3-10 lower than the direct exposure for the background population. However, for occupationally exposed workers the indirect exposure to PFCAs was comparable to the direct exposure (see also Figure 19).

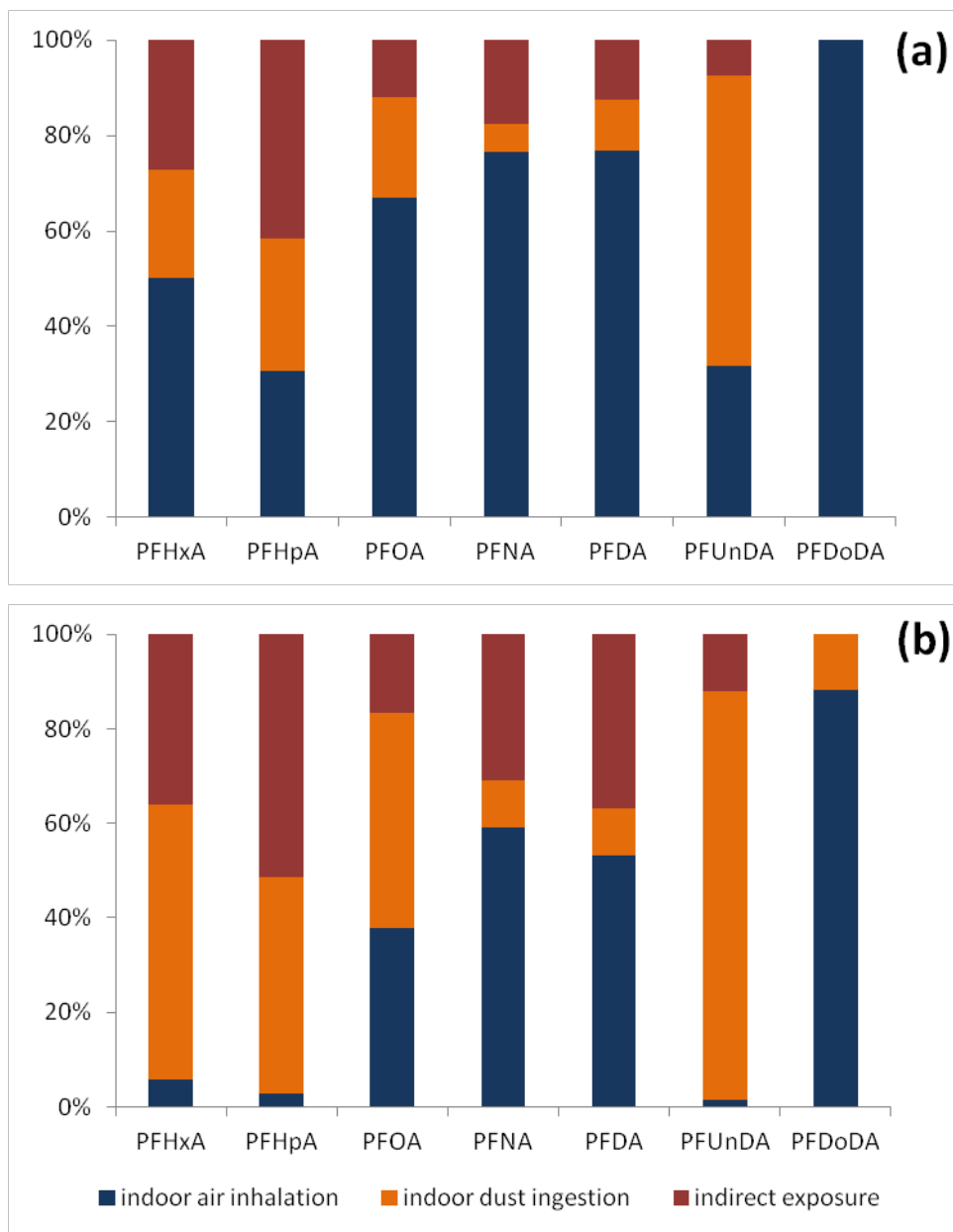

Table 34. Total exposure of FTOHs (ng kg<sup>-1</sup> day<sup>-1</sup>) from the use of DWR outdoor jackets for background and occupationally exposed populations estimated with low-exposure, intermediate and high-exposure scenarios. Values in brackets refer to the estimated indirect exposure to the corresponding PFCAs homologues using estimated biotransformation factors as explained in section 9.1.3.

	Direct exposure to PFCAs (ng day <sup>-1</sup> kg <sup>-1</sup> )		
	6:2-FTOH	8:2-FTOH	10:2-FTOH
	Background exposure		
Low	0.00 (0.00)	0.14 (0.00027)	0.05 (0.000091)
Intermediate	0.72 (0.0039)	1.08 (0.0058)	0.42 (0.0024)
High	24.13 (0.41)	21.69 (0.37)	12.95 (0.22)
	Occupational exposure		
Low	0.58 (0.0012)	3.61 (0.0072)	1.28 (0.0026)
Intermediate	3.15 (0.016)	14.12 (0.071)	5.21 (0.026)
High	29.93 (0.51)	65.02 (1.1)	24.55 (0.42)

Figure 18 and Figure 19 display the relative importance of individual pathways contributing to the total exposure of PFCAs for background and occupationally exposed populations respectively. Dermal uptake from wearing treated clothing, inhalation exposure to impregnation sprays and dermal uptake from impregnation sprays did not contribute to more than 1% for any of the scenarios or homologues and are therefore not shown in the figures. Despite that some of the parameters used to model exposure via dermal uptake probably represent an over estimation of the actual exposure situation (e.g. skin surface in contact with treated textile) the exposure via dermal uptake was negligible compared to other exposure routes. This can be explained by the slow absorption rate of PFASs through the skin (Fasano et al., 2005). Since indirect exposure occurred primarily via inhalation of FTOHs in indoor air (>90% of the total exposure to FTOHs) for both background and occupationally exposed populations only the sum of indirect exposure pathways is given in Figure 18 and Figure 19. For background exposed populations (Figure 18), inhalation of PFCAs in indoor air was the dominant pathway of exposure in the intermediate scenario for all homologues except PFHpA and PFUnDA (49-100% of the total exposure). Ingestion of PFCAs in house dust and indirect exposure to precursor compounds via inhalation were also significant exposure pathways for some homologues. For PFHxA and PFHpA indirect exposure contributed to 24 and 41% of the consumer product related exposure, whereas ingestion of dust contributed to 48% of the exposure of PFUnDA. The relative importance of different exposure pathways in the high exposure scenario varied greatly for the different homologues. Dust ingestion was an important exposure pathway for PFHxA, PFHpA, PFOA and PFUnDA (40-83% of the consumer product related exposure). Inhalation of PFCAs in indoor air was an important exposure pathway for PFOA, PFNA, PFDA and PFDoA (38-89% of the consumer product related exposure). Indirect exposure to FTOHs was most important for PFHxA, PFHpA, PFNA and PFDA (34-55% of the consumer product related exposure).

Figure 18. Relative importance of consumer product based exposure pathways for background exposed population (a) intermediate exposure (b) high exposure.



For occupationally exposed populations (Figure 19), indirect exposure to PFCAs via inhalation of FTOHs was the dominant exposure pathway for all homologues except PFDoA (53-75% of total exposure). It should be noted, however, that indirect exposure for PFDoA was not considered in these calculations since 12:2-FTOH was not measured in the indoor air samples. Inhalation of PFCAs in indoor air was the second most important exposure pathway (11-30% of total consumer product related exposure). Indirect exposure to PFCAs was the most important exposure pathway also in the high exposure scenario for several PFCAs homologues. However, ingestion of house dust was a relatively more important exposure pathway in the high exposure scenario compared to the intermediate scenario. In the high exposure scenario, hand-to-mouth contact with treated clothing also made a small contribution (2-18%) to the total consumer product related exposure.

Figure 19. Relative importance of exposure pathways for occupationally exposed population (a) intermediate exposure (b) high exposure.

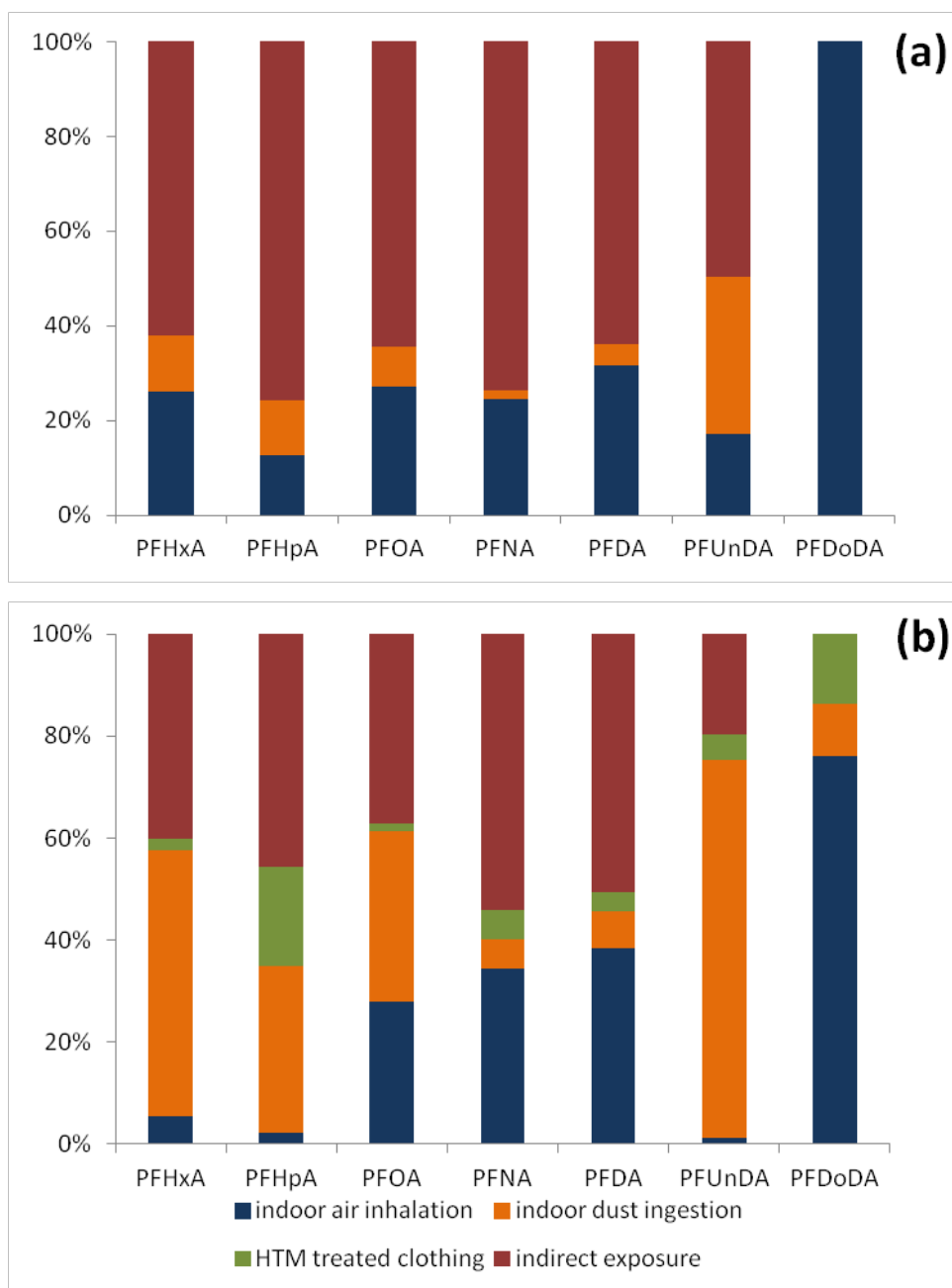
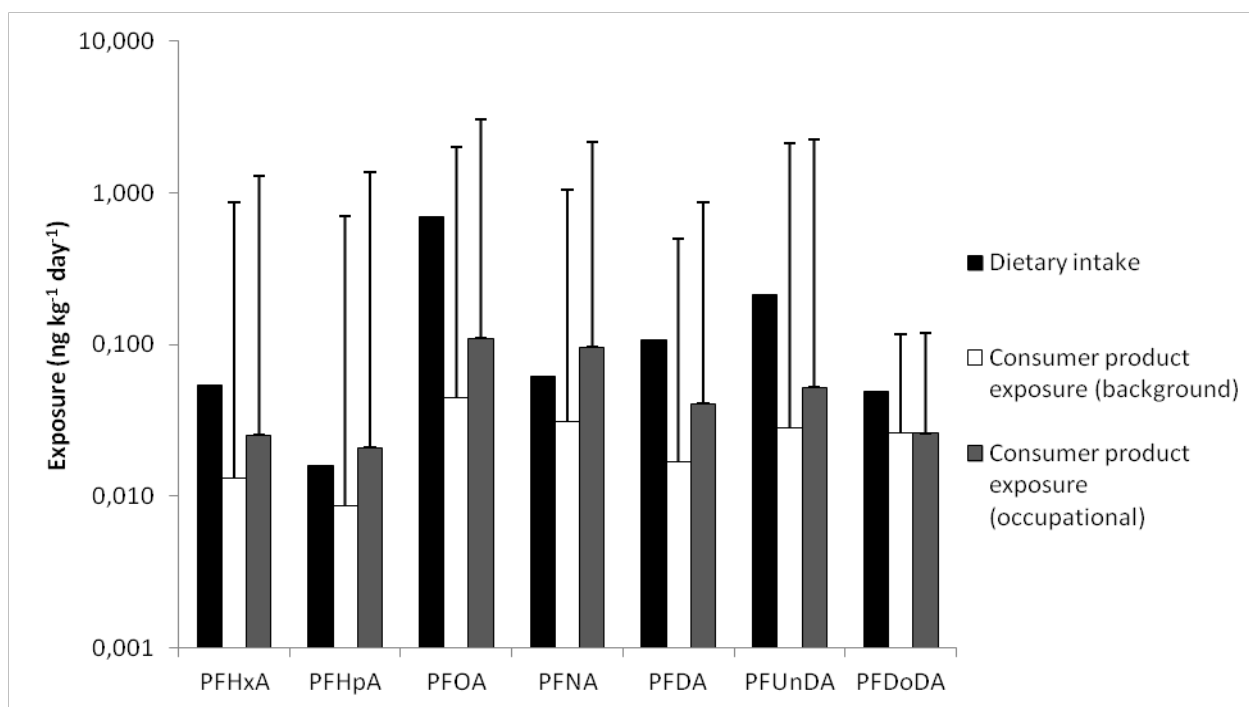

Figure 20 shows a comparison of the exposure related to DWR jackets estimated here with average dietary intake estimated from Sweden (Vestergren et al., 2012). Average dietary exposure was a factor of 3-10 times higher than the intermediate exposure scenario for consumer product related exposure. However, for populations receiving an occupational exposure in outdoor clothing stores the difference between dietary intake and consumer product exposure is smaller and for PFHpA and PFNA the consumer product related exposure exceeds the dietary intake. If the high exposure scenario is considered, exposure to DWR outdoor jackets becomes a far more important exposure pathway compared to exposure via dietary intake for all the homologues considered in this study.

Figure 20. Comparison of total product related exposure to PFCAs with estimated average dietary intake from Sweden (Vestergren et al., 2012). Solid bars represent the intermediate scenario and positive error bars represent the high exposure scenario.



### 9.3 Relevance of exposure to DWR jackets compared to other exposure pathways

In this study consumer product exposure to DWR jackets via direct contact events and via indoor dust ingestion and indoor air inhalation was quantified. The overall conclusion from the exposure modeling results is that DWR outdoor jackets contribute to a minor part of the total exposure to PFCAs compared to the dietary intake for the general population. However, given the large variability in exposure to consumer products, as demonstrated by the intermediate and high exposure scenario, DWR jackets may result in an elevated exposure to some sub-groups of the general population. Since, the high exposure scenario for the background population is several-fold higher than the average dietary intake, this study demonstrates that extensive use of DWR outdoor clothing, impregnating sprays or other treated textiles will result in an elevated exposure to PFCAs. These model estimations are generally in agreement with the study of Fraser et al., (2012) who observed a weak but statistically significant positive correlation between serum concentrations of PFCAs in office workers and indoor air concentrations of FTOHs. For occupationally exposed workers, the intermediate exposure for several PFCAs is within a factor of 1-3 of the average dietary intake. It may therefore be expected that chronic occupational exposure to DWR jackets would result in serum concentrations of PFCAs which are significantly higher than the background population. To further investigate the relative importance of DWR outdoor jackets as a source of human exposure paired measurements of PFCAs in serum of occupationally exposed people and PFASs in air and dust samples would be a useful experiment.

This exposure modeling study demonstrates that the most relevant exposure pathways related to DWR outdoor jackets are inhalation of indoor air and ingestion of house dust. Exposure to PFASs occurring via dermal or hand-to-mouth contact with DWR jackets and inhalation or dermal uptake from impregnation sprays is negligible in this context. However, outdoor

clothing is only one of many types of treated fabrics that contribute to the levels of PFASs in indoor dust and air. In the outdoor clothing shop it is reasonable to assume that the elevated levels of FTOHs are directly linked to textiles treated with PFASs. It is, however, difficult to assess the fraction of PFASs contributed from different consumer products to the levels of PFASs in indoor air and dust for the background scenarios (Shoeib et al., 2011; Huber et al., 2011). Further research of the migration of PFAS from treated textiles fate and transport of PFASs in the indoor environment would therefore enhance our understanding of human exposure to PFASs. For instance, average concentrations of volatile precursors in indoor air differs over two orders of magnitude between samples from Catalonia, Spain (Jogsten et al., 2012) and Vancouver, Canada (Shoeib et al., 2011). To what extent the differences in air and dust concentrations between different studies reflect the variability in use of PFAS treated consumer products or is an artifact of different techniques used for sampling and analysis is not known. Furthermore, only a few studies to date have measured a range of ionic and volatile PFASs in both indoor dust and indoor air (Huber et al., 2011; Shoeib et al., 2011). The results of this demonstrate that exposure both inhalation of air and ingestion of dust are important exposure pathways. Future studies of indoor exposure should therefore attempt to monitor both PFCAs and volatile precursor compounds in all indoor media.

The results of this study demonstrate that both direct and indirect (metabolism of FTOHs) exposure to PFCAs make an important contribution to the total exposure from DWR jackets. Since the estimated biotransformation rates used in this study were derived from rats (Fasano et al., 2005, Martin et al., 2005; Fasano et al., 2009, Nabb et al., 2007; Himmelstein et al., 2011), the estimated indirect exposures are associated with a larger degree uncertainty compared to direct exposures. The relative importance of indirect exposure estimated in this study is, however, in general agreement with the study by Fraser et al., (2012) who observed a weak but significant relationship between FTOHs in indoor air and serum concentrations of PFCAs. Further toxicokinetic modeling studies of humans receiving a high chronic exposure to FTOHs would be useful to better constrain biotransformation factors and the relative importance of indirect exposure. Regarding the indirect exposure to PFCAs it is also possible that compounds such as fluorotelomer acrylates and fluorotelomer olefins (Langer et al., 2010) could contribute to the indirect exposure of PFCAs. However, the knowledge of biotransformation of these compounds is poorly investigated and the monitoring studies that measure these compounds in air are few (Langer et al., 2010).

## 10 Conclusions, recommendations, scientific impact and outlook

Especially in Denmark, Sweden, Switzerland and Germany studies regarding the kind and use of PFASs in textile products and impregnation solutions have been performed. However, most of the studies are close to 10 years old and not relevant anymore, since the awareness about the negative features, especially PFOS, PFOA and PFOA-precursor products has led to a dramatic change in this field of application. With the planned and voluntary phase-out of PFOA until 2015, it can be predicted that the shift towards PFASs with a perfluorinated chain length of  $< C_7$  will be still ongoing.

So far this study does not confirm the “phase-out” approach of several sports and outdoor jackets producers. The 16 jackets purchased during the project have been selected based on their garment and finishing. In general concentrations were lower than those reported earlier, however a shift from  $C_8$  to  $C_6$  and even shorter chain derivatives has not been observed so far.

It has been shown that outdoor jackets emit PFASs to the environment. The volatile fluorotelomer alcohols are emitted into the air with average releases up to 49% for 10:2-FTOH. This compound showed the highest release from the jackets analyzed and the highest concentrations in the air sampled. The difference in release between the short-chain FTOHs and the longer-chain FTOHs could be explained by the fact that the jackets were bought some months before the air sampling. The solvent extractions were also performed some months before the air experiments. It is possible that 6:2-FTOH and 8:2-FTOH were already emitted during their storage, causing lower releases in the air once measured. Therefore, we assume a total release of 100% for 8:2-FTOH and a total release of 90% for 10:2-FTOH. FOSEs were not found in the air samples, as they were not present in the jackets. This indicates that treatment based on POSF chemistry is not widely used.

However, since we do not have any concentration values from jackets directly following their production, as well as the losses following their transport from the place of production to the country being sold, e.g. Germany, the uncertainties for a proper calculation of the air emission are too high.

The emission of FTOHs into air from consumer products should be researched more thoroughly since it has been shown that there is a positive correlation between FTOHs in the air and PFOA concentrations in human serum.

Another emission route of PFASs from outdoor jackets is through washing water. Eight PFASs were released during washing, of which PFOA was the most important compound. The release of PFOA and PFHxA from the investigated jacket pieces during washing was higher than 100%. So far, there is no clear explanation for this.

PFASs can also be released from the use of impregnating agents. It has been shown that 79 % of the 6:2-FTOH present in the impregnating agent was released into the air during the flow-through study. Other neutral compounds besides FTOHs were not present in the investigated impregnating agents. Washing of jackets with impregnating agent resulted in a high release of PFPeA and PFHxA. This can not only be explained by the addition of the impregnating agent or the jackets. So far, no other source has been found which explains the high concentrations of these compounds. Additional research has to be done to elucidate this.

The environmental load of the different PFASs from outdoor jackets is low, but surely contributes as one source to the overall PFASs burden. Thus outdoor jackets, and presumably those jackets being DWR based on PFASs-chemistry, are one source among many others of PFASs. The scenario with the highest amount of jackets sold in Germany models a load of 0.27 kg of PFOA, which explains somewhat less than 0.25% of the total load in wastewater in Germany. The other compounds measured in washing water showed lower concentrations. The environmental load from air emissions showed higher numbers than for the emission in washing water, mainly caused by the higher concentrations of FTOHs in the jackets. The load of 10:2-FTOH was highest in this study, with an amount of 2.40 kg emitted to the air per year for the highest scenario.

However, if an initial concentration directly after the fabrication of 5 mg 8:2-FTOH per jacket would be considered already a scenario considering that 25% of the imported jackets into Germany contain such PFASs, would lead to an air emission of 110 kg. This is a measurable, but still only a small fraction of the expected annual flux of FTOHs.

Assuming a content of 0.1% (1%) non-polymeric PFASs as initial impurities of the polymeric PFASs would result in 30 - 75 kg (300 - 750 kg) non-polymeric PFASs per year being imported into Germany via DWR jackets. These assumptions are in the range with the numbers calculated for other countries as.

Calculating the average PFOA-concentration in  $\mu\text{g}/\text{kg}$  and taking again the scenario with the lowest amount (15,000 t) of imported Outdoor jackets results in an import of 70 g PFOA per year for Germany.

For the impregnation of textiles, excluding carpets, estimation on the PFAs use of about 40 t for the EU has been done. Quite vaguely these numbers can be put into relation with the estimated global release of 75 t FTOHs stemming from textile treatment.

However, as mentioned above, these estimations are associated with some uncertainties which are difficult to quantify and do not take into account the eventual formation of PFOA via precursors.

A further conclusion from this study is that DWR jackets are a minor source of human exposure to PFCAs for the general population compared to dietary intake. For occupationally exposed workers in outdoor clothing stores the exposure from DWR jackets can, however, be significant and result in an elevated exposure compared to the general population. The main exposure pathways are volatilization, abrasion or wear from jackets and subsequent inhalation of indoor air and indoor dust.

A drawback of this modeling study is the fragmented nature of the exposure calculations using concentrations of PFASs in exposure media from different studies. Future studies investigating the exposure to DWR jackets should ideally target a group of occupationally exposed workers who would volunteer to wear personal monitors (dust and passive air samplers) and donate blood samples.

Design and function are often first priorities in the choice of chemicals for clothes. With respect to completely fluorine-free alternatives, it is necessary to check what functions are to be replaced, since there is not one alternative but several. Waterproof functions can be replaced by using impermeable materials such as fabrics coated with PVC, polyurethane or polyacrylates, but these do not provide breathable properties. Tightly woven and mangled



fabrics are relatively waterproof themselves. Certain fabrics, e.g. polyester and nylon, are more naturally dirt repellent than others, such as cotton. For breathable materials, paraffin wax emulsions or silicones can be used, but they are not dirt-repellent or oil-repellent. Water repellency and washing durability are worse for paraffin wax emulsions than for fluorocarbons. Other environmental and health problems may arise if alternatives are used, e.g. plasticizers in PVC. PFASs strongest advantage compared with PFASs free alternatives is that they are dirt-repellent (KEMI, 2006).

## 11 References

3M, 2000a. POSF life cycle waste stream estimates.

Ahrens, L., Felizeter, S., Sturm, R., Xie, Z., Ebinghaus, R., 2009. Polyfluorinated compounds in waste water treatment plant effluents and surface waters along the River Elbe, Germany. *Marine Poll. Bull.* 58, 1326-1333

Ahrens, L., Shoeib, M., Harner, T., Lee, S., Guo, R., Reiner, E., 2011. Wastewater treatment plant and landfills as sources of polyfluoroalkyl compounds to the atmosphere. *Environ. Sci. Technol.* 45, 8098-8105.

Barber, J., Berger, U., Chaemfa, C., Huber, S., Jahnke, A., Temme, C., Jones, K., 2007. Analysis of per- and polyfluorinated alkyl substances in air samples from northwest. Europe. *J. Environ. Monit.* 9, 530-541.

Barton, C. A. Botelho, M. A., Kaiser, M. A., 2009. Solid Vapor Pressure and Enthalpy for Perfluorooctanoic acid. *J. Chem. Eng. Data*, 54, 752-755.

Begley, T. H., White, K., Honigfort, P. Twaroski, M. L., Neches, R., Walker, A., 2005. Perfluorochemicals: Potential sources of and migration from food packaging. *Food Addit. Contam.* 22, 1023-1031

Bluesign, 2013a. Found at: <http://www.bluesign.com/>, retrieved: 20.03.2014

Bluesign, 2013b, bluesign system substances list (BSSL) Consumer safety limits, Version 3.2, effective from May 01, 2013, Found at:

[http://www.google.de/url?sa=t&rct=j&q=&esrc=s&source=web&cd=1&ved=0CDUQFjAA&url=http%3A%2F%2Fwww.bluesign.com%2Findustry%2Findocenter%2Fdownloads%2FdownloadFile%2F2%2Find-bssl%2F1-bssl-v3-2-1-pdf&ei=EfYuU-HIGsTOygO9iIK4Cw&usq=AFQjCNGEq4qLjSVOrYKDPIJaQdZZmv1kzw&sig2=tZM\\_bPVDmz0oLK2GG1QTNw&bvm=bv.62922401,d.bGQ&cad=rja](http://www.google.de/url?sa=t&rct=j&q=&esrc=s&source=web&cd=1&ved=0CDUQFjAA&url=http%3A%2F%2Fwww.bluesign.com%2Findustry%2Findocenter%2Fdownloads%2FdownloadFile%2F2%2Find-bssl%2F1-bssl-v3-2-1-pdf&ei=EfYuU-HIGsTOygO9iIK4Cw&usq=AFQjCNGEq4qLjSVOrYKDPIJaQdZZmv1kzw&sig2=tZM_bPVDmz0oLK2GG1QTNw&bvm=bv.62922401,d.bGQ&cad=rja), retrieved: 20.03.2014

Buck, R.C., Franklin, J., Berger, U., Conder, J.M., Cousins, I.T., De Voogt, P., Jensen, A.A., Kannan, K., Mabury, S.A., Van Leeuwen, S.P.J., 2011. Perfluoroalkyl and polyfluoroalkyl substances in the environment: Terminology, classification and origins. *Integr. Environ. Assess. Manag.* 7, 513-541.

Berger, U., Herzke, D., 2006. Per- and polyfluorinated alkyl substances (PFASs) extracted from textile samples. *Organohalogen Compounds* 68, 2023-2026.

BTE, 2012, Taschenbuch des Textileinzelhandels 2012, Found at:

<http://de.statista.com/statistik/daten/studie/157542/umfrage/textil-und-bekleidungsumsatz-im-nicht-textilhandel-in-deutschland>, retrieved 24.03.2014

Busch, J., Ahrens, L., Sturm, R., Ebinghaus, R., 2010. Polyfluoroalkyl compounds in landfill leachates. *Environmental Pollution* 158, 1467-1471.

China Dyeing and Printing Association, 2009. China Textile Industry PFOS Application Investigation Report. (in Chinese) cited in Lim et al., 2010.

COPCC, 2003. World trade center indoor environment assessment: Selecting contaminants of potential concern and setting health-based bench marks. Contaminants of potential concern comitee, World trade center indoor air task force working group. Found at:

[http://www.epa.gov/wtc/reports/contaminants\\_of\\_concern\\_benchmark\\_study.pdf](http://www.epa.gov/wtc/reports/contaminants_of_concern_benchmark_study.pdf), retrieved 20.03.2014

## Understanding exposure pathways of PFASs via use of PFASs-containing products –risk estimation for man and environment

- Davis, S., Mirick, D., 2006. Soil ingestion in children and adults in the same family. *J. Exp. Sci. Environ. Epid.* 16, 63–75.
- De Silva, A. O., Mabury, S. A., 2006. Isomer distribution of perfluorocarboxylates in human blood: Potential correlation to source. *Environ. Sci. Technol.* 40, 2903–2909.
- Dinglasan-Panlilio, M., Mabury, S., 2006. Significant residual fluorinated alcohols present in various fluorinated materials. *Environ. Sci. Technol.* 40, 1447-1453.
- Eftig, E.E., van Veen, M.P., 1998. Human exposure to butylbenzyl phthalate - a source effect chain approach. RIVM-Report No 630040002. Bilthoven, The Netherlands, National institute of public health and the environment (RIVM).
- Environment Canada, 2006. Perfluorinated Carboxylic Acids (PFCA) and Precursors. An Action Plan for Assessment and Management. Found at: <http://publications.gc.ca/pub?id=294663&sl=0>, retrieved: 24.03.2014
- Environment Canada, 2012. Report .Perfluorooctanoic Acid, its Salts, and its Precursors. Screening Assessment. August 2012. [http://www.ec.gc.ca/ese-ees/370AB133-3972-454F-A03A-F18890B58277/PFOA\\_EN.pdf](http://www.ec.gc.ca/ese-ees/370AB133-3972-454F-A03A-F18890B58277/PFOA_EN.pdf), retrieved 20.03.2014.
- Ellis, D., Martin, J., Mabury, S., Hurley, M., Sulbaek Andersen, M., Wallington, T., 2003. Atmospheric lifetime of fluorotelomer alcohols. *Environ. Sci. Technol.* 37, 3816-3820.
- Ellis, D.A., Martin, J. W., De Silva, A. O., Mabury, S. A., Hurley, M. D. Sulbaek Andersen, M. P., Wallington, T. J., 2004. Degradation of fluorotelomer alcohols: A likely atmospheric source of perfluorinated carboxylic acids. *Environ. Sci. Technol.* 38;3316–3321.
- EOG, 2012, Press release. Found at: [http://www.outdoor-show.de/od-wAssets/pdf/en/EOG\\_Interim-Report\\_Press-Release.pdf](http://www.outdoor-show.de/od-wAssets/pdf/en/EOG_Interim-Report_Press-Release.pdf), retrieved: 20.03.2014
- Eschauzier, C., Trier, X., Bengtström, L., Frömel, T., de Voogt, P., Knepper, T. P., 2012. Characterization and biodegradation of two technical mixtures of side-chain fluorinated acryl copolymers. Poster at the 4th international workshop Per- and Polyfluorinated Alkyl Substances – PFASs, November 7-9 2012, Idstein, Germany.
- EU, 2010. Commission Regulation (EU) No 757/2010 of 24.08.2010; Official Journal of the European Union, 25.08.2010.
- EU, 2006. Directive 2006/122/EC of the European parliament and of the council.
- European Commission, 2010. Analysis of the risks arising from the industrial use of Perfluorooctanoic acid (PFOA) and Ammonium Perfluorooctanoate (APFO) and from their use in consumer articles. Evaluation of the risk reduction measures for potential restrictions on the manufacture, placing on the market and use of PFOA and APFO. Final Report (20.12.2008-20.10.2009), European Commission, DG Enterprise and Industry, Unit G.2 – Chemicals, Brussels; RPS Advies B.V., Delft, The Netherlands. [http://ec.europa.eu/enterprise/sectors/chemicals/files/docs\\_studies/final\\_report\\_pfoa\\_pfos\\_en.pdf](http://ec.europa.eu/enterprise/sectors/chemicals/files/docs_studies/final_report_pfoa_pfos_en.pdf), retrieved 17.02.2014.
- European Commission, 2011. The Textile and Clothing sector and EU trade policy. [http://trade.ec.europa.eu/doclib/docs/2011/october/tradoc\\_148259.pdf](http://trade.ec.europa.eu/doclib/docs/2011/october/tradoc_148259.pdf), retrieved 17.02.2014.
- Eurostat, 2004. How Europeans spend their time- everyday life of women and men. Luxemburg, Office for official publications for the European Communities. Found at:

## Understanding exposure pathways of PFASs via use of PFASs-containing products –risk estimation for man and environment

[http://epp.eurostat.ec.europa.eu/cache/ITY\\_OFFPUB/KS-58-04-998/EN/KS-58-04-998-EN.PDF](http://epp.eurostat.ec.europa.eu/cache/ITY_OFFPUB/KS-58-04-998/EN/KS-58-04-998-EN.PDF), retrieved: 20.03.2014

eVent Fabrics, 2013, Website, Found at: <http://eventfabrics.com/>, retrieved: 20.03.2014

Expofacts, 2006. European exposure factors sourcebook. <http://expofacts.jrc.ec.europa.eu/>, retrieved 03.10.2013

Fasano, W., Kennedy, G.L., Szostek, B., Farrar, D.G., Ward, R.J., Haroun, L., Hinderliter, P.M., 2005. Penetration of ammonium perfluorooctanoate through rat and human skin in vitro. *Drug. Chem. Toxicol.* 28, 79–90.

Fasano, W.J., Carpenter, S.C., Gannon, S.A., Snow, T.A., Stadler, J.C., Kennedy, G.L., Buck, R.C., Korzeniowski, S.H., Hinderliter, P.M., Kemper, R.A., 2006. Absorption, distribution, metabolism, and elimination of 8-2 fluorotelomer alcohol in the rat. *Toxicol. Sci.* 91, 341–355.

Fasano, W.J., Sweeney, L.M., Mawn, M.P., Nabb, D.L., Szostek, B., Buck, R.C., Gargas, M.L., 2009. Kinetics of 8-2 fluorotelomer alcohol and its metabolites, and liver glutathione status following daily oral dosing for 45 days in male and female rats. *Chem. Biol. Interact.* 180, 281–295.

Fiedler, S., Pfister, G., Schramm, K-W., 2010. Poly- and perfluorinated compounds in household consumer products. *Toxicological & Environmental Chemistry* 92, 1801-1811.

Fischer, H., Krätke, R., Platzek, T., 2006. *Bundesgesundheitsblatt – Gesundheitsforschung – Gesundheitsschutz* 2006 49:1063-1067; Springer Medizin Verlag 2006.

Fluoropolymer Manufacturers Group, 2002. Presentation Slides, U.S. EPA Administrative Record AR226-1094, U.S. Environmental Protection Agency, Washington, DC.

FOEN, 2009. Substance flow analysis for Switzerland - Perfluorinated surfactants perfluorooctanesulfonate (PFOS) and perfluorooctanoic acid (PFOA), Federal Office for the Environment FOEN, Switzerland. Found at: <http://www.bafu.admin.ch/publikationen/publikation/01066/index.html?lang=en>, retrieved: 20.03.2014

FOV Fabrics AB, 2014, Found at: <http://www.fov.se/start.htm>, retrieved: 20.03.2014

Fraser, A., Webster, T., Watkins, D., Nelson, J., Stapleton, H., Calafat, A., Kato, K., Shoeib, M., Vieira, V., McClean, M., 2012. Polyfluorinated compounds in serum linked to indoor air in office environments. *Environ. Sci. Technol.* 46, 1209-1215.

Frömel, T., Knepper, T., 2010. Biodegradation of fluorinated alkyl substances. *Rev. Environ. Contam. Toxicol.* 208, 161-177.

Fromme, H., Schlummer, M., Möller, A., Gruber, L., Wolz, G., Ungewiss, J., Böhmer, S., Dekant, W., Mayer, R., Liebl, B., Twardella, D., 2007. Exposure of an adult population to perfluorinated substances using duplicate diet portions and biomonitoring data. *Environ. Sci. Technol.* 41, 7928-7933.

Gellrich, V., Stahl, T., Knepper, T. P., 2012. Behavior of perfluorinated compounds in soils during leaching experiments. *Chemosphere* 87, 1052-1056.

GermanFashion Modeverband Deutschland e.V., 2011. Wichtigste Importländer des deutschen Bekleidungsgewerbes, Found at: <http://de.statista.com/statistik/daten/studie/218179/umfrage/Wichtigste-Importländer-des-deutschen-Bekleidungsgewerbes>, retrieved: 24.03.2014

- Giesy, J., Kannan, K., 2001. Global distribution of perfluorooctane sulfonate in wildlife. *Environ. Sci. Technol.* 35, 1339-1342.
- Glensvig, G., Buck, C., Abildgaard, A., 2008. Chemical substances in selected impregnating agents. Danish Environmental protection agency. Found at: [http://www2.mst.dk/udgiv/publikationer/2004/Kortlaegning/050\\_Eksponering\\_af\\_kemiske\\_stoffer\\_i\\_impregningsmidler.pdf](http://www2.mst.dk/udgiv/publikationer/2004/Kortlaegning/050_Eksponering_af_kemiske_stoffer_i_impregningsmidler.pdf), retrieved: 20.03.2014
- Gröber, 2013. Press conference during ISPO 2013, 29.01.2013, Found at: [http://press.ispo.com/Project-specific/Pressemitteilungen/Press-Munich/DE/ispo\\_munich\\_2013\\_hpk\\_statement\\_vgf.pdf](http://press.ispo.com/Project-specific/Pressemitteilungen/Press-Munich/DE/ispo_munich_2013_hpk_statement_vgf.pdf), retrieved: 20.03.2014
- Halopolymer JSC, 2012. Website, Found at: <http://www.halopolymer.com/about/company>, retrieved: 26.07.2013.
- Handel + Verkauf, 2013. Wie schädlich sind Outdoorjacken. *Handel + Verkauf, sport + mode 05-2013*, 30-31
- Handelsblatt, 2011, Umsatz der führenden Outdoor-Marken, Found at: <http://de.statista.com/statistik/daten/studie/225982/umfrage/Umsatz-der-fuehrenden-Outdoor-Marken/>, retrieved: 24.03.2014
- Herzke, D., Posner, S., Olsson, E., 2009. Survey, screening and analyses of PFCs in consumer products. Project report 09/47, TA-2578/2009, Swerea IVF. Found at <http://www.miljodirektoratet.no/old/klif/publikasjoner/2578/ta2578.pdf>, retrieved: 20.03.2014
- Herzke, D., Olsson, E., Posner, S., 2012. Perfluoroalkyl and polyfluoroalkyl substances (PFASs) in consumer products in Norway - a pilot study. *Chemosphere* 88, 980-987.
- Hansen, K.J., Clemen, L.A., Ellefson, M.E., Johnson, H.O., 2001. Compound-specific, quantitative characterization of organic fluorochemicals in biological matrices. *Environ. Sci. Technol.* 35, 766-770.
- Himmelstein, M.W., Serex, T.L., Buck, R.C., Weinberg, J.T., Mawn, M.P., Russell, M.H., 2011. 8:2 fluorotelomer alcohol: A one-day nose-only inhalation toxicokinetic study in the Sprague-Dawley rat with application to risk assessment. *Toxicology*. 291, 122-132.
- Houde, M.; Martin, J. W.; Letcher, R. J.; Solomon, K. R.; Muir, D. C. G., 2006. Biological monitoring of perfluoroalkyl substances: A review. *Environ. Sci. Technol.* 40, 3463-3473.
- Huber, S., Haug, L.S., Schlabach, M., 2011. Per- and polyfluorinated compounds in house dust and indoor air from northern Norway – A pilot study. *Chemosphere* 84, 1686-1693.
- Hundley, S. G., Sarrif, A. M.; Kennedy, G. L., 2006. Absorption, distribution, and excretion of ammonium perfluorooctanoate (APFO) after oral administration to various species. *Drug Chem. Toxicol.* 29, 137-145.
- INVISTA, 2013, Found at: <http://www.cordura.com/en/fabric-technology/index.html>, retrieved: 20.03.2014
- IVC, 2011. Die Chemiefaser-Industrie in der Bundesrepublik Deutschland 2010/2011, Industrievereinigung Chemiefaser e. V..
- Jack Wolfskin, 2013, Press release from 24.01.2013, Found at: <http://www.jack-wolfskin.com/Newsroom-1019650-2/tabid-9161/tabid-9162/Jack-Wolfskin-Texapore-materials-to-be-free-from-PFOA-from-Autumn-Winter-2013.aspx>, retrieved: 20.03.2014

- Jack Wolfskin, 2014, Texapore Website, Found at: <http://www.texapore.com/en#>, retrieved: 20.03.2014
- Jahnke, A., Berger, U., Ebinghaus, B., Temme, C., 2007a. Latitudinal gradient of airborne polyfluorinated alkyl substances in the marine atmosphere between Germany and South Africa (53n-33s). *Environ. Sci. Technol.* 41, 3055-3061.
- Jahnke, A., Huber, S., Temme, C., Kylin, H., Berger, U., 2007b. Development and application of a simplified sampling method for volatile polyfluorinated alkyl substances in indoor and environmental air. *J. Chromatogr. A* 1164, 1-9.
- Jensen, A. A., Poulsen, P. B., 2008. Survey and environmental/health assessment of fluorinated substances in impregnated consumer products and impregnating agents. Survey of Chemical Substances in Consumer Products No. 99, FORCE Technology, DMU, University of Aarhus, Danish Ministry of the Environment. Found at: <http://chm.pops.int/Portals/0/download.aspx?d=UNEP-POPS-NIP-GUID-ArticlePaperPFOSInv-4.En.pdf>, retrieved: 20.03.2014
- Jogsten, I.E., Nadal, M., van Bavel, B., Lindström, G., Domingo, J.L., 2012. Per- and polyfluorinated compounds (PFCs) in house dust and indoor air in Catalonia, Spain: Implications for human exposure. *Chemosphere.* 39, 172–180.
- Jürling, H., Müller, J., Schlummer, M., Biegel-Engler, A., 2011. Per- and polyfluorinated Compounds in Consumer Products. Poster presented at 3rd international workshop “Anthropogenic Perfluorinated Compounds”, 15.-17. June 2011, Amsterdam, NL.
- KEMI Report Nr. 7/06. 2006. Perfluorinated substances and their uses in Sweden. Swedish Chemicals Agency, Stockholm, ISSN: 0284-1185.
- Kennedy, G., Butenhoff, J.L., Olsen, G.W., O’Connor, J.C., Seacat, A.M., Perkins, R.G., Biegel, L.B., Murphy, S.R., Farrar, D.G., 2004. The toxicology of perfluorooctanoate. *Crit. Rev. Toxicol.* 34, 351–384.
- Kissa, E., Schick, M., Hubbard, A., 1997. Fluorinated surfactants and repellents, second ed. Wiley, Weinheim, Germany.
- Kissel, J.C., Shirai, J.H., Richter, K.Y., Fenske, R.A., 1998. Empirical investigation of hand to mouth transfer of soil. *Bull. Environ. Contam. Toxicol.* 60, 379–386.
- Knepper, T. P., Lange, F. T., 2012. Polyfluorinated Chemicals and Transformation Products. In: Barceló, D., Kostianoy, A.G., *The Handbook of Environmental Chemistry 17*. Springer, Heidelberg, Germany.
- Lacasse, K., Baumann, W., 2004. Textile Chemicals, Environmental Data and Facts., Springer, Heidelberg, Germany.
- Langer, V., Dreyer, A., Ebinghaus, R., 2010. Polyfluorinated compounds in residential and nonresidential indoor air. *Environ. Sci. Technol.* 44, 8075-8081.
- Lau, C., Anitole, K., Hodes, C., Lai, D., Pfahles-Hutchens, A., Seed, J., 2007. Perfluoroalkyl acids: A review of monitoring and toxicological findings. *Toxicological Sciences* 99, 366-394.
- Lee Lin Apparel, 2011, Found at: <http://www.lee-lin-apparel.com/lms/pages/AboutUs.aspx>; retrieved: 22.07.2013
- Lei, Y., Wania, F., Mathers, D., Mabury, S., 2004. Determination of vapor pressures, octanol-air, and water-air partition coefficients for polyfluorinated sulfonamide, sulfonamidoethanols, and telomer alcohols. *J. Chem. Eng. Data* 49, 1013-1022.

- Lim, T. C., Wang, B., Huang, J., Deng, S., Yu, G., 2011. Emission Inventory for PFOS in China: Review of Past Methodologies and Suggestions. *Scientific World Journal* 11, 1963–1980, DOI: 10.1100/2011/868156.
- Martin, J., Muir, D., Moody, C., Ellis, D., Kwan, W., Solomon, K., Mabury, S., 2002. Collection of airborne fluorinated organics and analysis by gas chromatography/chemical ionization mass spectrometry. *Anal. Chem.* 74, 584-590.
- Martin, J. W., Smithwick, M. M., Braune, B. M., Hoekstra, P. F., Muir, D. C. G., Mabury, D. C. G., 2004. Identification of long-chain perfluorinated acids in biota from the Canadian arctic. *Environ. Sci. Technol.* 38, 373–380.
- Martin, J. W., Mabury, S. A., O'Brien, P. J., 2005. Metabolic products and pathways of fluorotelomer alcohols in isolated rat hepatocytes. *Chem. Biol. Interact.* 155, 165–180.
- Mawn, M. P., McKay, R. G., Ryan, T. W., Szostek, B., Powley, C. R., Buck, R. C., 2005. Determination of extractable perfluorooctanoic acid (PFOA) in water, sweat simulant, saliva simulant and methanol from textile and carpet samples by LC/MS/MS. *Analyst.* 130, 670–678.
- MEP (Ministry of environmental protection of China), 2008. Comments on the Revised Draft Risk Profile for SCCP. Found at: [http://chm.pops.int/Portals/0/Repository/comments\\_draftRME2008/UNEP-POPS-POPRC-DRME-08-CHI-SCCP.English.PDF](http://chm.pops.int/Portals/0/Repository/comments_draftRME2008/UNEP-POPS-POPRC-DRME-08-CHI-SCCP.English.PDF), retrieved: 20.03.2014
- Müller, C., Gerecke, A., Bogdal, C., Wang, Z., Scheringer, M., 2012. Atmospheric fate of poly- and perfluorinated alkyl substances (PFASs): I. day-night patterns of air concentrations in summer in Zürich, Switzerland. *Environ. Pollut.* 169, 196-203.
- Nabb, D. L., Szostek, B., Himmelstein, M. W., Mawn, M. P., Gargas, M. L., Sweeney, L. M., Stadler, J. C., Buck, R. C., Fasano, W. J., 2007. In vitro metabolism of 8-2 fluorotelomer alcohol: Interspecies comparisons and metabolic pathway refinement. *Toxicol. Sci.* 100, 333–344.
- Norin, H., Schulze, P.-E., 2007. Fluorerade miljögifter i impregneringsmedel. Rapport 901909-2. Naturskyddsforeningen (Swedish Society for Nature Conservation).
- OECD, 2006. Results of survey on production and use of PFOS, PFASs, and PFOA, related substances and products/mixtures containing these substances. Found at: <http://search.oecd.org/officialdocuments/displaydocumentpdf/?doclanguage=en&cote=env/jm/mono%282006%2936>, retrieved: 20.03.2014
- OECD, 2007. Lists of PFOS, PFASs, PFOA, PFCA, Related Compounds and Chemicals that may degrade to PFCA. Environment, Health and Safety Publications. Series on Risk Management No. 21, revised in 2007. Found at: <http://search.oecd.org/officialdocuments/displaydocumentpdf/?doclanguage=en&cote=env/jm/mono%282006%2915>, retrieved: 20.03.2014
- OECD, 2007b. Report of an OECD Workshop on Perfluorocarboxylic Acids (PFCA) and Precursors. OECD Environment, Health and Safety Publications. Series on Risk Management No. 23, ENV/JM/MONO(2007)11.
- OECD, 2011. PFCs: Outcome of the 2009 survey. Survey on the production, use and release of PFOS, PFASs, PFOA, PFCA, their related substances and products/mixtures containing these substances. Series on Risk Management No.24, Organisation for Economic Co-operation and Development OECD.



## Understanding exposure pathways of PFASs via use of PFASs-containing products –risk estimation for man and environment

- OECD, 2013, OECD/UNEP Globl PFC Group, Synthesis paper on per- and polyfluorinated chemicals (PFCs), Environment, Health and Safety, Environment Directorate, OECD. Found at: [http://www.oecd.org/env/ehs/risk-management/PFC\\_FINAL-Web.pdf](http://www.oecd.org/env/ehs/risk-management/PFC_FINAL-Web.pdf), retrieved: 20.03.2014
- Oeko Tex, 2014a, Oeko Tex 100 Fact Sheet, Found at: [https://www.oeko-tex.com/media/downloads/Factsheet\\_OETS\\_100\\_EN.pdf](https://www.oeko-tex.com/media/downloads/Factsheet_OETS_100_EN.pdf), retrieved: 20.03.2014
- Oeko Tex, 2014b, Website, Found at: <https://www.oeko-tex.com/de/manufacturers/manufacturers.xhtml>, retrieved: 20.03.2014
- Patagonia, 2014, the footprint chronicles, Found at: [http://www.patagonia.com/pdf/en\\_US/Factory\\_List\\_6-2010.pdf](http://www.patagonia.com/pdf/en_US/Factory_List_6-2010.pdf), retrieved: 20.03.2014
- Patagonia, 2014, Recycle, Website, Found at: [http://www.patagonia.com/us/common-threads/recycle?src=vty\\_recyc](http://www.patagonia.com/us/common-threads/recycle?src=vty_recyc), retrieved: 20.03.2014
- Paul, A.G., Jones, K.C., Sweetman, A.J., 2009. A First Global Production, Emission, and Environmental Inventory For Perfluorooctane Sulfonate. *Environ. Sci. Technol.* 43, 386-392.
- Prevedouros, K, Cousins, I.T., Buck, R.C., Korzeniowski, S.H., 2006. Sources, fate and transport of perfluorocarboxylates. *Environ. Sci. Technol.* 40, 32-44.
- Pyua, 2014, Closed-Loop-Recycling, Found at: <http://www.pyua.de/pyua-recycling.html>, retrieved: 20.03.2014
- Ring, K.L., Kalin, T., Kishi, A., 2002. Fluoropolymers, CEH Marketing Research Report 2002, Menlo Park, CA, 2002 cited in Prevedouros et al., 2006
- RIWA, 2009. Jaarrapport 2009; De Rijn; RIWA Rijnwaterbedrieven 2009. Found at: [http://www.riwa-rijn.org/uploads/tx\\_deriva/173\\_JR2009\\_Ned.pdf](http://www.riwa-rijn.org/uploads/tx_deriva/173_JR2009_Ned.pdf), retrieved: 20.03.2014
- RIWA, 2010. Jaarrapport 2010 ; De Rijn; RIWA Rijnwaterbedrieven 2010. Found at: [http://www.riwa-rijn.org/uploads/tx\\_deriva/RIWA\\_Jaarrapport\\_2010\\_internet.pdf](http://www.riwa-rijn.org/uploads/tx_deriva/RIWA_Jaarrapport_2010_internet.pdf), retrieved: 20.03.2014
- REACH EC 1907/2006. Found at: <http://eur-lex.europa.eu/LexUriServ/LexUriServ.do?uri=CONSLEG:2006R1907:20121009:EN:PDF>, retrieved: 20.03.2014
- Russell, M.H., Berti, W.R., Szostek, B., Buck, R.C., 2008. Investigation of the biodegradation potential of a fluoroacrylate polymer product in aerobic soils. *Environ. Sci. Technol.* 42, 800-807.
- Russell, M.H., Berti, W.R., Szostek, B., Wang, N., Buck, R.C., 2010. Evaluation of PFO formation from the biodegradation of a fluorotelomer-based urethane polymer product in aerobic soils. *Polym. Degr. Stabil.* 95, 79-85.
- Schlummer M., Gruber, L.; Fiedler, D., Kizlauskasa, M., Müller, M. et al., 2013. Detection of fluorotelomer alcohols in indoor environments and their relevance for human exposure. *Environ. Internat.* 57-58, 42-49,
- Schröder, V., 2009. Abwassereinträge von per/polyfluorierten Chemikalien (PFC) in der Textilindustrie. Vortrag anlässlich Fachgespräch des MUNLV und UBA, Polyfluorierten organischen Verbindungen, 19. Juni 2009 Berlin, TEGEWA, Frankfurt. Found at: [http://www.umweltbundesamt.de/sites/default/files/medien/pdfs/abwassereintraege\\_von\\_pfc\\_in\\_textilindustrie-schroeder.pdf](http://www.umweltbundesamt.de/sites/default/files/medien/pdfs/abwassereintraege_von_pfc_in_textilindustrie-schroeder.pdf), retrieved: 20.03.2014

- Schöffel, 2014, Technologies/materials science, Venturi, Found at:  
<http://www.schoeffel.de/en/inspiration/en-technologien-materialwissen/venture>, retrieved: 20.03.2014
- Schulze, P., Norin, H., 2006. Fluorinated pollutants in all-weather clothing. Swedish Society for Nature Conservation, Friends of the Earth Norway – Report 2/2006, Norwegian Society for the Conservation of nature; ISBN 82-7478-254-2.
- Shoeib, M., Harner, T., Webster, G., Lee, S., 2011. Indoor sources of poly- and perfluorinated compounds in Vancouver, Canada: Implications for human exposure. Environ. Sci. Technol. 45, 7999-8005.
- Sport-Fachhandel, 2011a, “Besonders die Sortimente Wintersport und Outdoor sind das Öl im Getriebe”, Found at: <http://www.sport-fachhandel.com/Aktuell/besonders-die-sortimente-wintersport-und-outdoor-sind-das-oel-im-getriebe.html>, retrieved: 17.02.2011
- Sport-Fachhandel, 2011b. “EOG: Deutschland bleibt der Branchen-Primus“, Found at: <http://www.sport-fachhandel.com/de,de/news/d-a-ch/eog-deutschland-bleibt-der-branchen-primus,article00001989.html>, retrieved: 17.02.2014.
- Statistisches Bundesamt, 2014, Found at: <https://www.destatis.de/DE/Startseite.html>, retrieved: 24.03.2014.
- Stock, N., Furdui, V., Muir, D.G., Mabury, S.A., 2007. Perfluoroalkyl Contaminants in the Canadian Arctic: Evidence of Atmospheric Transport and Local Contamination, Environ. Sci. Technol. 41, 3529-3536.
- SympaTex, 2014, Website, Website, Found at: <http://www.sympatex.com/en/>, retrieved: 20.03.2014.
- Taiwanfluoro, 2013, Website, Found at: [http://www.taiwanfluoro.com/eng/?page\\_id=196](http://www.taiwanfluoro.com/eng/?page_id=196), retrieved: 22.02.2014
- TEGEWA & FCI, 2007. Informationsserie Textilchemie.  
[https://www.vci.de/Downloads/Textilchemie\\_Textheft.pdf](https://www.vci.de/Downloads/Textilchemie_Textheft.pdf), retrieved 17.02.2014
- Textil-Recycling K.&A. Wenkhaus GmbH, 2014, Website, found at:  
[http://www.wenkhaus.de/index.php?option=com\\_content&view=category&layout=blog&id=20&Itemid=22&lang=de](http://www.wenkhaus.de/index.php?option=com_content&view=category&layout=blog&id=20&Itemid=22&lang=de), retrieved: 20.03.2013.
- The North Face, 2012. MTS test report.; [http://www.thenorthface.co.uk/blog/wp-content/uploads/2013/03/Third\\_Party\\_Laboratory\\_Test.pdf](http://www.thenorthface.co.uk/blog/wp-content/uploads/2013/03/Third_Party_Laboratory_Test.pdf); retrieved 17.02.2014
- Toray Industries, 2013, Toray ActiveSport Fabrics Specification Table, Found at:  
<http://www.torayentrant.com/specifications/index.html>, retrieved: 20.03.2014.
- Trudel, D., Horowitz, L., Wormuth, M., Scheringer, M., Cousins, I.T., Hungerbühler, K., 2008. Estimating consumer exposure to PFOS and PFOA. Risk Anal. 28, 251-269.
- UBA, 2003. Integrierte Vermeidung und Verminderung der Umweltverschmutzung (IVU) - Referenzdokument über die besten verfügbaren Techniken in der Textilindustrie mit ausgewählten Kapiteln in deutscher Übersetzung. Umweltbundesamt. Found at:  
[http://www.umweltbundesamt.de/sites/default/files/medien/419/dokumente/bvt\\_textilindustrie\\_vv.pdf](http://www.umweltbundesamt.de/sites/default/files/medien/419/dokumente/bvt_textilindustrie_vv.pdf), retrieved: 20.03.2014.
- UBA, 2009. Per- und polyfluorierte Chemikalien. Einträge vermeiden - Umwelt schützen, Umweltbundesamt. Found at:  
<http://www.umweltbundesamt.de/sites/default/files/medien/publikation/long/3812.pdf>, retrieved: 20.03.2014.

- UBA, 2011. Umweltstandards in der Textil- und Schuhbranche, ein Leitfaden auf Basis der BVT-Merkblätter der EU, Umweltbundesamt. Found at: <http://www.umweltbundesamt.de/sites/default/files/medien/publikation/long/4128.pdf>, retrieved: 20.03.2014.
- USEPA, 1997. Exposure factors handbook. Washington, US EPA. Found at: <http://www.epa.gov/ncea/efh/pdfs/efh-complete.pdf>, retrieved: 20.03.2014.
- USEPA, 2008. Perfluorooctanoic acid (PFOA) and Fluorinated Telomers, 2008 Annual Progress Reports, <http://epa.gov/oppt/pfoa/pubs/stewardship/preports2.html#summary>, retrieved: 20.03.2014
- USEPA, 2013. 2010/2015 PFOA Stewardship Program. Found at: <http://www.epa.gov/oppt/pfoa/pubs/stewardship/>, retrieved: 20.03.2014.
- Vaude, 2011, Vaude Training Apparel, Found at: [http://www.vaude.com/out/documents/downloads/1863\\_Apparel\\_EN\\_web.pdf](http://www.vaude.com/out/documents/downloads/1863_Apparel_EN_web.pdf), retrieved: 20.03.2014.
- VDS Sportfachhandel, 2014, Found at: <http://www.vds-sportfachhandel.de/index.php?id=2>, retrieved: 20.03.2014
- Vejrup, K., Lindblom, B., 2002. Analysis of perfluorooctanesulfonate compounds in impregnating agents, wax and floor polish products. National Environmental Research Institute, Denmark. Found at: <http://eng.mst.dk/media/mst/69099/17.pdf>, retrieved: 20.03.2014.
- Vernez, D., Bruzzi, R., Kupferschmidt, H., De-Batz, A., Droz, P., Lazor, R., 2006. Acute respiratory syndrome after inhalation of waterproofing sprays: a posteriori exposure-response assessment in 102 cases. *J. Occ. Environ. Hyg.* 3, 250–261.
- Vestergren, R., Cousins, I. T., Trudel, D., Wormuth, M., Scheringer, M., 2008. Estimating the contribution of precursor compounds in consumer exposure to PFOS and PFOA. *Chemosphere* 73, 1617–1624.
- Vestergren, R., Berger, U., Glynn, A., Cousins, I. T., 2012. Dietary exposure to perfluoroalkyl acids for the Swedish population in 1999, 2005 and 2010. *Environ. Int.* 49, 120–127.
- VFC, 2011, Website, Found at: <http://vfc.com/about/global-presence>; retrieved: 25.11.11
- Vierke, L., Staude, C., Biegel-Engler, A., Drost, W., Schulte, C., 2012. Perfluorooctanoic acid (PFOA) – main concerns and regulatory developments in Europe from an environmental point of view. *Env. Sci. Europe*, 24, 1-11.
- W. L. Gore & Associates, 2014a. Website, Found at: <http://www.gore-tex.com/remote/Satellite/content/responsibility/pfc-ptfe>; retrieved 20.02.2014.
- W. L. Gore & Associates, 2014b, Gore-Tex, Website, Found at: <http://www.gore-tex.com/remote/Satellite/content/our-fabrics#!>, retrieved: 20.03.2014.
- W. L. Gore & Associates, 2014c. Website, Frequently asked questions, Found at: <http://www.gore-tex.com/remote/Satellite/content/customer-service/faq/5>, retrieved: 20.03.2014.
- Wallington, T., Hurley, M., Xia, J., Wuebbles, D., Sillman, S., Ito, A., Penner, J., Ellis, D., Martin, J., Mabury, S., Nielsen, O., Sulbaek Andersen, M., 2006. Formation of C<sub>7</sub>F<sub>15</sub>COOH (PFOA) and other perfluorocarboxylic acids during the atmospheric oxidation of 8:2 fluorotelomer alcohol. *Environ. Sci. Technol.* 40, 924-930.

## Understanding exposure pathways of PFASs via use of PFASs-containing products –risk estimation for man and environment

- Walters, A., Santillo, D., 2006. Uses of Perfluorinated Substances. Greenpeace Research Laboratories Technical Note 06/2006, GRL-TN-06-2006. Found at: <http://www.greenpeace.to/publications/uses-of-perfluorinated-chemicals.pdf>, retrieved: 20.03.2014.
- Wang, N., Szostek, B., Buck, R., Folsom, P., Sulecki, L., Capka, V., Berti, W., Gannon, J., 2005. Fluorotelomer alcohol biodegradation-direct evidence that perfluorinated carbon chains breakdown. *Environ. Sci. Technol.* 39, 7516-7528.
- Wang, T., Wang, Y., Liao, C., Cai, Y., Jiang, G., 2009. Perspectives on the inclusion of Perfluorooctane sulfonate into the Stockholm Convention on persistent organic pollutants. *Environ. Sci. Technol.* 43, 5171–5175.
- Washburn, S.T., Bingman, T. S., Braithwaite, S. K., Buck, R. C., Buxton, L. W., Clewell, H. J., Haroun, L. A., Kester, J. E., Rickard, R. W., Shipp, A. M., 2005. Exposure assessment and risk characterization for perfluorooctanoate in selected consumer articles. *Environ. Sci. Technol.* 39, 3904–3910.
- Washington, J. W.; Ellington, J. J.; Jenkins, T. M.; Evans, J. J.; Yoo, H.; Hafner, S. C., 2009, Degradability of an acrylate-linked, fluorotelomer polymer in soil. *Environ. Sci. and Technol.* 43, 6617-6623.
- Westat, 1987. Household solvent products: A national usage survey. Washington, USEPA. Found at: [http://www.epa.gov/oppt/exposure/presentations/efast/westat\\_1987b\\_household\\_solvent\\_products.pdf](http://www.epa.gov/oppt/exposure/presentations/efast/westat_1987b_household_solvent_products.pdf), retrieved: 20.03.2014.
- Will, R., 2012. Fluoropolymer Trade & Development. Presentation at SPI-Plastics Industry Trade Association Conference, 17-18 October, Las Vegas, USA.
- World Bank Group, 2007. Environmental, Health, and Safety Guidelines for Textile Manufacturing.
- Wormuth, M., Scheringer, M., Hungerbuhler, K., 2005. Linking the use of scented consumer products to consumer exposure to polycyclic musk fragrances. *J. Ind. Ecol.* 9, 237–258.
- Yarwood, G., Kembal-Cook, S., Keinath, M., Waterland, r.L., Korzeniowski, S.H., Buck, R.C., Russell, M.H., Washburn, S.T., 2007. High-resolution atmospheric modeling of fluorotelomer alcohols and perfluorocarboxylic acids in the North American Troposphere. *Environ. Sci. Technol.* 41, 5756-5762.
- Zeit Online, “Lieber nackt als unfair”. Found at: <http://www.zeit.de/reisen/2010-12/outdoor-ausruestung>, retrieved 17.02.2014

## 12 Supplement information

### 12.1 Major garments

#### GORE-TEX<sup>®</sup>

GORE-TEX<sup>®</sup> uses an expanded polytetrafluoroethylene (ePTFE) membrane with a microporous structure. Besides being waterproof, these membranes are also breathable. The membrane is also coated with an oleophobic layer, to prevent penetrations of body oil into the fabric. The membrane is bound to high-performance fabrics in order to construct a GORE-TEX<sup>®</sup> laminate. Depending on the qualifications of the product, the laminate has been expanded with different types of performance textiles. Most laminates are 2- or 3-layered (W. L. Gore & Associates, 2014b).

#### eVent<sup>®</sup>

eVent<sup>®</sup> uses a patented waterproof/breathable membrane made of ePTFE and coated with polyester (eVent Fabrics, 2013).

#### Texapore

Texapore has been developed by the company Jack Wolfskin. The weather protection layer is combined with a face (outer) fabric, which determines the additional characteristics, e.g. durability, texture, and weight. It can be a 2 layer construction (face fabric and weather protection layer) or a 2,5 or 3 layer construction. A special layer or lining protects the weather protection layer; this is laminated to the weather and protection layer and the face fabric. A coating can also be applied to the face fabric. Membranes which are weatherproof and laminated to the face fabric are generally pore-free. Hybrid constructions use both technologies, e.g. the microporous coating and a pore-free membrane (Jack Wolfskin, 2014).

The following information on the use of PFASs in their garments has been published by the company: „A general statement on the use of PFASs cannot be given. Current research focuses on a specific group of fluorocarbons, namely PFOA and PFOS, due to their possible health effects. Our waterproof and water-repellent products currently contain PFASs, since it is state of the art. Our impregnating agents however, do not use these compounds.“

With a new campaign Jack Wolfskin declares that Texapore materials will be free from PFOA from Autumn/Winter 2013 (Jack Wolfskin, 2013).

#### Sympatex<sup>®</sup>

The Sympatex<sup>®</sup> membrane is a 5 µm thick membrane that is laminated on a textile base, providing protection against moisture. It is made of a polyester-ether-copolymer (PET): a mix of water repellent polyester and water vapour permeable polyether and is PTFE free. The functional textile is bluesign<sup>®</sup>-certified and Oeko-Tex Standard 100 certified in product class 1 for safe textile products. The PET-membrane is completely recyclable. Sympatex<sup>®</sup> produces four different laminates for clothing. In a shell laminate, the membrane is attached to the outer fabric to form the laminate, while the lining lies loosely underneath. In a lining laminate, the membrane is attached to the lining. The outer fabric is positioned loosely on top. The 3-layer laminate is formed by the outer fabric, the Sympatex<sup>®</sup> membrane and a lining. Sympatex<sup>®</sup>

works together with Rudolf Chemie, a company specialized in the production of textile care, textile coating, construction, leather and other applications (Sympatex, 2014).

#### Venturi

Venturi by Schöffel is a laminate, which is breathable. The structure of Venturi shows coarse and fine molecule combinations. The water vapour escapes through the coarse molecular structure (Schöffel, 2014).

#### Ceplex

The Ceplex (VauDe) membrane is waterproof, windproof, and breathable achieved through lamination of a PU membrane with the outer material (Vaude, 2011).

#### Dermizax

Dermizax, made by Toray, is a waterproof, windproof and breathable membrane consisting of Nylon or PR and PU (Toray Industries, 2013).

#### Garments free of PFASs

Environmentally friendly production processes as best available techniques (BVT) in the textile and shoe industries have been compiled and described by the UBA (2003, 2011). The use of these BVT is mandatory in the EU to gain production permission. Suppliers from outside the EU obeying these guidelines are favoured. (UBA, 2011; World Bank Group, 2007).

The company Pyua produces an outdoor jacket with an oeko-tex standard 100- and bluesign®-certified membrane which is advertised as “free of any fluorocarbons” (Pyua, 2014).

## 12.2 Information from “Statistisches Bundesamt”

Trade movements from and to Germany:

Table 35. Mixtures containing fluorinated chemicals

Länder	Ausfuhr: Gewicht	Ausfuhr: Wert	Einfuhr: Gewicht	Einfuhr: Wert
	t	Tsd. EUR	t	Tsd. EUR
<b>2010</b>				
Belgien (ab 1999)	253,2	1.251	356,0	2.025
Dänemark	14,1	89	-	-
Finnland	22,3	131	-	-
Frankreich	131,1	553	619,7	3.294
Italien	8,4	109	295,1	1.524
Niederlande	353,8	1.514	2.109,9	12.899
Österreich	214,5	1.334	3,3	38
Polen	37,0	227	-	-
Portugal	9,0	67	-	-
Rumänien	20,7	106	-	-
Schweden	75,5	452	-	-
Slowenien (ab 05/92)	17,3	111	-	-
Spanien	62,6	236	2.878,3	12.471
Tschechische Republik (ab 1993)	28,7	183	27,0	274
Ungarn	18,6	107	-	-
Vereinigtes Königreich	0,8	62	530,1	2.503
Norwegen	29,0	279	-	-
Russische Föderation (ab 05/92)	93,2	321	-	-
Schweiz	119,9	717	-	-
Türkei	8,2	48	-	-
Schiffs- und Luftfahrzeugbedarf	12,1	170	-	-
<b>Summe</b>	<b>1.530,0</b>		<b>6819,4</b>	

(Statistisches Bundesamt, 2014); . WA38247800 Mischungen, FKW oder HFKW enthaltend, größer 5 t; Ab Monatsbericht Januar 2009 wurde das Aufbereitungs- und Veröffentlichungssystem der Außenhandelsstatistik modernisiert. Im Rahmen dieser Umstellung sind die Außenhandelsdaten vor Januar 2009 - aufgrund neuer Geheimhaltungsregelungen und neuer Zuschätzverfahren für Meldeausfälle und Warenverkehre unterhalb der Schwellengrenze - nur eingeschränkt vergleichbar; Wiesbaden 2011; Stand: 06.12.2011 / 12:24:58



Table 36. Textile-finishing products.

Länder	Ausfuhr: Gewicht	Ausfuhr: Wert	Einfuhr: Gewicht	Einfuhr: Wert
	t	Tsd. EUR	t	Tsd. EUR
<b>2010</b>				
Belgien (ab 1999)	12.024,4	16.668	4.848,3	5.248
Dänemark	1.262,0	1.562	18,1	18
Finnland	594,6	1.703	2,5	7
Frankreich	7.528,2	13.002	25.509,9	23.933
Griechenland	1.359,3	2.431	-	-
Italien	14.591,4	21.061	2.746,7	3.825
Niederlande	6.283,8	9.678	2.958,4	5.017
Österreich	2.139,4	4.322	121,8	271
Polen	4.027,0	6.112	1.371,8	626
Portugal	3.242,0	6.838	6,5	11
Rumänien	769,3	2.297	-	-
Schweden	680,1	1.631	65,5	154
Slowakei (ab 1993)	846,8	1.866	0,3	1
Spanien	4.457,2	9.054	4.482,3	3.816
Tschechische Republik (ab 1993)	1.888,4	3.943	7.135,0	5.245
Ungarn	726,5	1.040	31,1	30
Vereinigtes Königreich	3.400,2	7.676	870,4	1.552
Russische Föderation (ab 05/92)	945,5	2.279	-	-
Schweiz	4.867,7	8.140	4.639,2	12.428
Türkei	6.588,7	14.795	488,5	737
Ägypten	1.226,0	2.647	-	-
Marokko	596,6	929	-	-
Mauritius	579,6	1.213	-	-
Südafrika	727,1	1.757	-	-
Brasilien	1.057,1	2.970	38,9	62
Kolumbien	855,9	2.092	-	-
Mexiko	790,8	1.849	30,1	125
Venezuela	535,1	2.139	-	-
Vereinigte Staaten von Amerika	941,2	2.945	1.157,4	5.810
Bangladesch	6.656,7	11.681	-	-
Volksrepublik China	5.554,1	13.857	476,2	1.031
Japan	115,6	419	1.015,8	7.292
Indien	2.194,6	6.511	161,0	452
Indonesien	1.270,9	2.414	-	-
Islamische Republik Iran	785,2	1.904	-	-
Republik Korea	718,7	1.574	219,1	943
Pakistan	2.730,9	6.440	-	-
Singapur	563,7	1.163	22,9	20
Sri Lanka	970,7	2.411	-	-
Arabische Republik Syrien	648,2	1.113	-	-
Taiwan	606,6	1.312	7,7	44
Thailand	1.145,8	2.616	12,6	22
<b>Summe</b>	<b>109.493,6</b>		<b>3.141,7</b>	

(Statistisches Bundesamt, 2014); WA38099100 Appretur- o. Endausstattungsmittel, Textilindustrie größer 500 t. Ab Berichtsmonat Januar 2009 wurde das Aufbereitungs- und Veröffentlichungssystem der Außenhandelsstatistik modernisiert. Im Rahmen dieser Umstellung sind die Außenhandelsdaten vor Januar 2009 - aufgrund neuer Geheimhaltungsregelungen und neuer Zuschätzverfahren für Meldeausfälle und Warenverkehre unterhalb der Schwellengrenze - nur eingeschränkt vergleichbar. (C)opyright Statistisches Bundesamt, Wiesbaden 2011, Stand: 29.11.2011 / 09:07:44

### 12.3 Compilation of studies concerning impregnating agents

Table 37. Concentration of PFASs in impregnating agents; (taken from Fiedler et al., 2010; Herzke et al., 2009; Norin and Schulze, 2007; Vejrup et al, 2002).

Impregnating agent *	6:2-FTOH (µg/mL)	8:2-FTOH (µg/mL)	10:2-FTOH (µg/mL)	PFHxA (µg/mL)	PFHpA (µg/mL)	PFOA (µg/mL)	PFNA (µg/mL)	PFOS (µg/mL)	Sum analyzed PFASs (µg/mL)	References
A1	1.2	61	32			0.4		<LOD	95	Fiedler et al., 2010
A2	<LOD	2.9	1.7			0.1		<LOD	5	Fiedler et al., 2010
A3	2.1	52	32			0.2		<LOD	86	Fiedler et al., 2010
A4	1.3	43	23			0.2		<LOD	67	Fiedler et al., 2010
A5	0,6	30	17			0.4		<LOD	47	Fiedler et al., 2010
A6	<LOD	0.5	0.3			<LOD		<LOD	0.8	Fiedler et al., 2010
A7	<LOD	33	20			nd		<LOD	54	Fiedler et al., 2010
A8	<LOD	<LOD	<LOD			0.9		<LOD	0.9	Fiedler et al., 2010
A9	<LOD	<LOD	<LOD			3.6		<LOD	3.6	Fiedler et al., 2010
I1	0.5	54.8	22.4	0.03	0.05	0.2	0.6	<LOD	80.7	Herzke et al., 2009
I2	<LOD	<LOD	<LOD	<LOD	<LOD	<LOD	<LOD	<LOD	0.1	Herzke et al., 2009
I3	<LOD	<LOD	<LOD	<LOD	<LOD	<LOD	<LOD	<LOD	0.2	Herzke et al., 2009
I4	1.8	74.3	17.8	<LOD	0.01	<LOD	<LOD	<LOD	94	Herzke et al., 2009
I5	13.3	330.8	120.7	0.02	0.01	0.03	<LOD	<LOD	465	Herzke et al., 2009

\* (internal code of the references)

**Understanding exposure pathways of PFASs via use of PFASs-containing products –risk estimation for man and environment**

Impregnating agent *	6:2-FTOH (µg/mL)	8:2-FTOH (µg/mL)	10:2-FTOH (µg/mL)	PFHxA (µg/mL)	PFHpA (µg/mL)	PFOA (µg/mL)	PFNA (µg/mL)	PFOS (µg/mL)	Sum analyzed PFASs (µg/mL)	References
Ecco universal waterproofing spray	1.2	160	65	0.06	0.16	0.13	0.56	<LOD	230	Norin and Schulze, 2007
Armour	3.5	<LOD	<LOD	<LOD	<LOD	<LOD	<LOD	<LOD	3.5	Norin and Schulze, 2007
Nikwax TX Direct wash-in	<LOD	<LOD	<LOD	<LOD	<LOD	0.1	<LOD	<LOD	1	Norin and Schulze, 2007
Boston Raingard allover	11.4	429.6	144.5	0.1	<LOD	0.05	<LOD	0.009	585.7	Norin and Schulze, 2007
Kiwi select all protector	5.1	467.4	191.8	<LOD	0.1	0.08	0.2	0.009	670.6	Norin and Schulze, 2007
Imprenex plus	<LOD	<LOD	<LOD	<LOD	<LOD	<LOD	<LOD	0.08	0.1	Norin and Schulze, 2007
Nikwax nubuck & mocka proof	<LOD	<LOD	<LOD	<LOD	<LOD	<LOD	<LOD	<LOD	<LOD	Norin and Schulze, 2007
Springyard Waterproofer	21.1	858.0	265.6	<LOD	<LOD	<LOD	<LOD	0.02	1144.7	Norin and Schulze, 2007
XT	114.1	3244.1	1291.3	0.16	<LOD	0.05	<LOD	0.013	4649.8	Norin and Schulze, 2007
Boston protector	4.9	144.8	53.6	<LOD	<LOD	<LOD	<LOD	<LOD	203.3	Norin and Schulze, 2007
Nikwax TX. Direct spray-on	<LOD	<LOD	<LOD	<LOD	<LOD	<LOD	<LOD	<LOD	<LOD	Norin and Schulze, 2007
Atsko Waterguard	53.1	5691.9	3675.0	0.16	0.12	0.34	0.1	0.004	9421.1	Norin and Schulze, 2007
Collonil classic waterstop	4.9	631.6	245.7	0.1	0.3	0.7	1.8	<LOD	890.6	Norin and Schulze, 2007

Understanding exposure pathways of PFASs via use of PFASs-containing products –risk estimation for man and environment

Impregnating agent code of the references) (internal		6:2-FTOH (µg/mL)	8:2-FTOH (µg/mL)	10:2-FTOH (µg/mL)	PFOS (µg/mL)	Sum analyzed PFASs (µg/mL)	References
	Comment						
Impregnating agent - for leather and textile, Aerosol spray 01-1321					<LOD	<LOD	Vejrup et al, 2002
Impregnating agent - for leather and textile, Aerosol spray 01-1322					<LOD	<LOD	Vejrup et al, 2002
Impregnating agent - Anticolouring for socks, Aerosol spray 01-1323	Impregnating agent: fluorcarbon resin				<LOD	4	Vejrup et al, 2002
Impregnating agent - for leather,skin and textile, Aerosol spray 01-1324	Impregnating agent: fluorcarbon				<LOD	212	Vejrup et al, 2002
Impregnating agent - for textile Spray flask 01-1325					<LOD	<LOD	Vejrup et al, 2002
Impregnating agent - for textile Aerosol spray 01-1327					<LOD	<LOD	Vejrup et al, 2002
Impregnating agent - for leather and textile, Aerosol spray 01-1328					<LOD	<LOD	Vejrup et al, 2002
Impregnating agent - for leather and textile, Aerosol spray 01-1329					<LOD	<LOD	Vejrup et al, 2002
Impregnating agent – for leather and textile, Aerosol spray 01-1331					<LOD	<LOD	Vejrup et al, 2002
Impregnating agent - for wash of textile Liquid 01-1340					<LOD	<LOD	Vejrup et al, 2002
Impregnating agent - for wash of textile with down Liquid 01-1346					<LOD	<LOD	Vejrup et al, 2002

## 12.4 Environmental Emissions of PFASs

Table 38. Release and offsite transfer of surveyed PFASs (tonnes), from OECD, 2011.

Release media	Quantity	Days released	Accuracy
<b>Releases to the environment</b>			
Air	<9.0	10-365	10-50%
Water, Waste water treatment, Publicly Owned Treatment Works	<7.0	250-365	20-90%
On-site and off-site Landfills, and Underground injection	CBI	Not provided	50-70%
<b>Reuse, recycling or incineration</b>			
Incineration/recycle/recover	<225	Not provided	2-50%

CBI = Confidential Business Information

## 12.5 Companies involved in textile production

Table 39. Companies involved in the textile production for Patagonia.

Chenfeng (Kunshan) Apparel CO., LTD No.2 Chenfeng Road Kunshan China  
 Grand Union Trading Co. Feng Ze Qu Cheng Dong Xun Mei Ind Area Quanzhou China  
 Guangdong Esquel Textiles Co Ltd YangMei Garment Factory Yangmei Town FoShan 528515 China  
 Guangdong Esquel Textiles Co. Ltd. Garment Factory Cang Jiang Gaoming District Foshan 528500 China  
 NanHua Textiles Co. Ltd. Nanan County Panlong Development Zone Shuitou Town Nanan City 362342 China  
 Ningxia Zhongyin Cashmere Co. Ltd The Cashmere Industry Park Lingwu China  
 Pacific Eagle/ Hangzhou Chuan Yi Rubber & Plastic Co. Ltd. Standard Factory No. 4 Hangzhou 904 China  
 Qingdao Haksan Shoes Co.; Ltd. Baisanlihe Village Nanguan Tow Jiaozhou City 266300 China  
 Qingdao Youngone Sports Wear Co Ltd (FTY2) #1, Road 3, Jimo Qingdao 266200 China  
 Roll Sport Qisha village Shatian Town 523997 China  
 Shanghai Weijie Garment Co., Ltd. 1228 Huiping Road Nanxiang, Jiading Shanghai 201802 China  
 Simona (Stella - Group) Guanchang Road, The fourth industrial area of Xia Dongguan City China  
 Xinhua Factory Zhongshan Street Dragon Lake Jinjiang City China  
 Yue Yuen (Pou chen- Group) Pou Yuen Industrial City First Industrial Estate, Sanxiang Town Zhongshan China  
 GE Apparel Solutions Nos 13B Y 1B, Apartado Aereono 385 Cali Valle Colombia  
 Supertex S.A. Carrera 35 No-10-707 Acopi Yumbo Colombia  
 Industrias Atlanta S.A. C/o Desacarca Zona Industrial Pavas San Jose Costa Rica  
 Brooklyn Manufacturing Ltda de CV Calle Principal Colonia Jardines de San Marcos San Salvador El Salvador  
 IMPERIAL GARMENTS PLOT NO. 5 & 6, IDA PATANCHERU MEDAK DIST 502 319 India  
 Horfesh P.O.B 255 Horfesh Village 25115 Israel  
 Tefron Ltd./ Hi Tex Teradyon Industrial Zone 1 Blue Street P.O. BOX 1365 Misgav 20179 Israel  
 Yarca Sewing Plant Yarca Village Yarca village 24967 Israel  
 Cualquier Lavado S.A. de C.V. Kilometro 15 Carretera Tehuacan-Puebla N° 2 Cuayucatepec Tehuacan Mexico  
 Private Label Tehuacan S. de R.L. de C.V. Kilometro 107 - Tehuacan 4 S.C. Tepanco de Lopez Mexico  
 Rivercross Sewing Ave Del Obrero #3 Parque Industrial Del Norte H. Matamoros Mexico  
 Formosa Textil (NICA) S.A. KM 12 1/2 Carretera Norte Modulo No. 52 Managua Nicaragua  
 Dong-In Mountaineering Inst. 2F & 3F SFB #3 Bataan Economic Zone Marivele Philippines  
 Petrutex Bande, Carvalhosa 4590 Pacos De Ferreira Pacos De Ferreira Portugal  
 Castle Peak Holdings Public Co 384/81 Moo 4 Petchkasem Rd Bangkae Khet Bangkae Bangkok 10160 Thailand  
 CPG Garment Co.; Ltd. 2 Soi Pethkasem 50/2 Bagwah Pasricharoen Bangkok 10160 Thailand  
 OnSmooth 153 Moo 7 3rd T. Thawangtarn A. Saraphee Chiangmai 500140 Thailand  
 S.P. Brother Co Ltd 821 823/ Taksin Rd Thonburi Bangkok 10600 Thailand  
 Siam Knitwear and Garment Co. Ltd 159 Soi Rongnagan SrinakarinRd Bangkok Thailand  
 Thai Garment Export Co.,Ltd. (TG2/4) 50/5 Moo 4, Chaengwatana Rd., Pakkred Pakkred 11120 Thailand

Thai Garment Export Co.,Ltd.(TG1/3) 129 Moo 4 Petchkasem Rd., Omnoi Kratumban 74130 Thailand  
Thai Jichodo Co.; Ltd. (TJC) 99/7 Moo 1, Amphur Muang Laemchabung 12000 Thailand  
Thanulux 129/1 Chongnonthri Rd Chongnonthri Yannawa 10120 Thailand  
V.T. Garment Co. Ltd 602/40-50 Soi Chartsangkroh Sathupradit 48, Sathupradit Road, Bangkok 10120 Thailand  
Egedeniz Tekstil San. TIC A.S. Isciler Cad. NO: 176/2 35230 Alsancak Izmir Turkey  
Ercan Kancar Tekstil Isciler CAD n#176/2 Alsancak Izmir Turkey  
Inter Tekstil Isciler CAD n#176/3 Alsancak Izmir Turkey  
Alba's Garment Works 2978 Seaborg Ave Ventura 93003 United States  
Leegin Creative Leather Products 14022 Nelson Ave City of Industry 91746 United States  
Loretta's Fashions 3751 S. Broadway Place Los Angeles United States  
M&G Apparel 5901 Firestone Blvd. South Gate 90280 United States  
MANUAL CASTILLO CUTTING SERVICE 860 WEST 84TH STREET Hialeah 33014 United States  
Nature USA 3097 E. Ana St Rancho Domingue 90221 United States  
Nester Hosiery 1400 Carter Street Mount Airey 27030 United States  
Northridge Mills - 1st street 1901 First St. San Fernando 91340 United States  
Northridge Mills - Jessie street 701 Jessie St San Fernando 91340 United States  
P&Y T-Shirts & Silkscreening 2126 East 52nd Street Vernon 90058 United States  
Print Inc 1225 Park Center Dr Vista 92081 United States  
Prolific 2301 Industrial pkwy, Suite 1 Hayward United States  
Sand Mountain Cutting & Sewing 973 County Rd 257 Bryant 35958 United States  
Todd Rutkin 5801 S. Alameda Los Angeles 90001 United States  
Western Textile & Mfg 51 Joseph Ct. San Rafael 94903 United States  
Kanaan Saigon Co. Ltd Xa Duc Hoa Ha, huyen Duc Hoa, Tinh Long An Vietnam  
Kwang Viet Garment Co. Ltd. Unit 2, Cu Chi Town, Cu Chi District Ho Chi Minh 84 Vietnam  
Maxport - JSC 88 Ha Dinh Thanh Xuan District Hanoi Vietnam  
Palace Industries Co. Road 3, Tan Thuan E.P.Z. Tan Thuan Dong Ward, Dist. 7 Ho Chi Minh City Vietnam  
Company Nguyen Duc Canh Industrial Zone Tran Thai Tong Ward Thai Binh Vietnam  
Thanh Tri Garment Export Factory Km. 11, National Road 1A, Van Dien Town, Hanoi Vietnam  
Viet Ha Garment JSC No162 Nguyen Van Troi Street Vietnam

taken from: Patagonia (2012)

## 12.6 Recycling of DWR

### 12.6.1 Attempts of companies for Recycling

#### ECO Storm

The waterproof and breathable “Eco Storm”, designed by Teijin, is a DWR material being laminated with a membrane made out of 100% polyester, which can be reused in a closed-loop-recycling-procedure.

#### Closed-loop-recycling

The form of closed-loop-recycling is also an approach of Pyua with a textile recycling company (K. & A. Wenkhaus GmbH). Clothes are not collected by the retailers, but rather in collection bins in cities which are being used by consumers already. PYUA products that go into a collection bin then go to two professional textile-recycling companies, which then return the newly recovered materials from the products back into the system. This Closed-Loop-Recycling-System is used for polyester products.

Parts which are not going in the recycling process (e.g. zippers, buttons) are being re-used in other ways – for example in road construction. (Pyua, 2014; Textil-Recycling K.&A. Wenkhaus GmbH, 2014)

#### Patagonia Recycling

By recycling old products, Patagonia keeps many of the same materials in circulation for years. In 2005 they began taking back worn out Patagonia clothing for recycling. Today, any

Patagonia product can be returned, will be reused and recycled into new fabric or into a new product (Patagonia, 2014).

Gore Recycling

Gore had developed a technology for the recycling of laminates. In 1993 Gore offered post-consumer recycling for outerwear. This recycling program for specially designed garments was stopped. The consumers were not willing to return the garments for recycling (W. L. Gore & Associates, 2014c).

However, it is not exactly known what happens with the textiles, the main focus of all the attempts is the re-use of polyester fibres.

12.6.2 Standard substances lists

Table 40. Oeko-Tex 100 Limit values/issue 01.01.2011

Product class	I	II	III	IV
	Baby	In direct contact with skin	With no direct contact with skin	Decoration material
PFOS ( $\leftrightarrow$ g/m <sup>2</sup> ) <sup>1,2</sup>	1.0	1.0	1.0	1.0
PFOA (mg/m <sup>2</sup> ) <sup>3,2</sup>	0.1	0.25	0.25	1.0

<sup>1</sup> CAS-Nr. Various The individual substances are listed in supplement information; <sup>2</sup> For all material with a water and oir repellent finish or coating; <sup>3</sup>PFOA, CAS-Nr. 335-95-5; (Oeko Tex, 2014b)



Table 41. Blue Sign Standard substances list, fluorinated substances, part 1.

Fluorinated Substances					
Part 1		Limit Value Usage range			
Chemical Substances	CAS Number	A	B	C	Test Method
<b>PFAS Chemicals</b>					
Perfluoroalkylsulfonates (PASf) $F(CF_2)_nSO_3^-$ [n ≥ 5]	Several	Usage Ban // Traces: 20 µg/kg			Solvent Extraction // GC-MS or HPLC-MS
Perfluorohexane sulfonic acid / Perfluorohexane sulfonate (PFHxS)	355-46-4 / 432-50-7	Usage Ban // Traces: 20 µg/kg			
Perfluorooctane sulfonic acid / Perfluorooctane sulfonate (PFOS)	1763-23-1	Usage Ban // Traces: 1 µg/m <sup>2</sup>			
Perfluoroalkylsulfonamides $F(CF_2)_nSO_2NH_2$ [n ≥ 5]	Several	Usage Ban // Traces: 20 µg/kg			
Perfluoroalkylsulfonamidoethanols $F(CF_2)_nSO_2N(R)CH_2CH_2OH_2$ [n ≥ 5, R = H, -CH <sub>3</sub> , - CH <sub>2</sub> CH <sub>3</sub> ]	Several	Usage Ban // Traces: 20 µg/kg			
Perfluoroalkylsulfonamidoethyl (meth)acrylates $F(CF_2)_nSO_2N(R)CH_2CH_2OC(O)CH(R)=CH_2$ [n ≥ 5, R = H, -CH <sub>3</sub> , -CH <sub>2</sub> CH <sub>3</sub> ]	Several	Usage Ban // Traces: 20 µg/kg			
<b>PFBS Chemicals</b>					
Perfluorobutane sulfonic acid / Perfluorobutanesulfonates (PFBS) $F(CF_2)_4SO_3^-$	29420-49-3 / 29420-43-3	1.0 mg/kg ----- Monitoring			Solvent Extraction // GC-MS or HPLC-MS
Perfluorobutanesulfonamide $F(CF_2)_4SO_2NH_2$		50 mg/kg ----- Monitoring			
Perfluorobutanesulfonamidoethanols $F(CF_2)_4SO_2N(R)CH_2CH_2OH_2$ [R = H, -CH <sub>3</sub> , -CH <sub>2</sub> CH <sub>3</sub> ]	Several	15 mg/kg ----- Monitoring			
Perfluorobutanesulfonamidoethyl (meth)acrylates $F(CF_2)_4SO_2N(R)CH_2CH_2OC(O)CH(R)=CH_2$ [R = H, -CH <sub>3</sub> , -CH <sub>2</sub> CH <sub>3</sub> ]	Several	15 mg/kg ----- Monitoring			
<b>Fluorotelomer alcohols (FTOHs)</b> <b><math>F(CF_2)_nCH_2CH_2OH</math></b>	<b>Several</b>	Sum of all 50 mg/kg			
6:2 FTOH, Perfluorohexylethanol	647-42-7	Monitoring			Solvent Extraction // GC-MS or HPLC-MS
8:2 FTOH, Perfluorooctylethanol	678-39-7	Monitoring			
<b>Fluorotelomer Olefins (FTOs)</b>					
Perfluorohexylethene	25291-17-2	Monitoring			Solvent Extraction // GC-MS or HPLC-MS
Perfluorooctylethene	21652-58-4	Monitoring			

From: Bluesign Standard substances list (BSSL) (Bluesign, 2013b)

Table 42. Blue Sign Standard substances list, fluorinated substances, part 2.

Fluorinated Substances					
Part 2		Limit Value Usage range			
Chemical Substances	CAS Number	A	B	C	Test Method
<b>Fluorotelomer (Meth)Acrylates</b>	<b>Several</b>	Sum of all 50 mg/kg			
Perfluorohexylethylacrylate or methacrylate	Several	Monitoring			Solvent Extraction // GC-MS or HPLC-MS
Perfluorooctylethylacrylate or methacrylate	Several	Monitoring			
<b>Perfluorocarboxylic acid and salts (PFCA)</b>	<b>Several</b>	Sum of all 0.1 mg/kg			
Perfluorobutanoic acid (PFBA)	375-22-4	Usage Ban // Traces: 0.05 mg/kg Monitoring			Solvent Extraction // HPLC-MS
Perfluorohexanoic acid (PFHxA)	307-24-4	Usage Ban // Traces: 0.05 mg/kg Monitoring			
Perfluorooctanoic acid (PFOA)	335-67-1	Usage Ban // Traces: 0.05 mg/kg			
Perfluorononanoic acid (PFNA)	375-95-1	Usage Ban // Traces: 0.05 mg/kg Monitoring			
Perfluoroisobutylene	382-21-8	0.1 mg/kg			Solvent Extraction // GC-MS
Tetrafluoroethylene	116-14-3	1.0 mg/kg			Solvent Extraction // GC-MS

From: Bluesign Standard substances list (BSSL) (Bluesign, 2013b)

## 12.7 Quantitative measurements in Outdoor jackets

### 12.7.1 Method development

Method development was performed using two randomly chosen jackets (J5 and J6). Initially, methanol was used as extraction solvent, since methanol is a very common solvent applied to extract PFASs from solid samples. However, in this case, recovery rates for PFCAs and PFSAs, the two most important compound classes, was 0% for all compounds. This could be attributed to very strong matrix effects in terms of ion suppression in the ESI source. The reason for this was probably the good solubility of the dyes applied to the textile in methanol, which indeed was scratched off the first metal plate in the MS during instrument maintenance.

Therefore, the solvent was changed to acetone/acetonitrile (80/20; V/V), which did not dissolve the dyes as determined by visual inspection of the extracts. Two different processes were investigated: 24 h shaking on an orbital shaker and an ultrasonic treatment for 1 h. The results of this comparison are demonstrated in Figure 21.

Figure 21. Recoveries of PFCAs and PFSAs in J5 (top) and J6 (bottom) calculated by division of peak areas in extracts with those from solvent standards

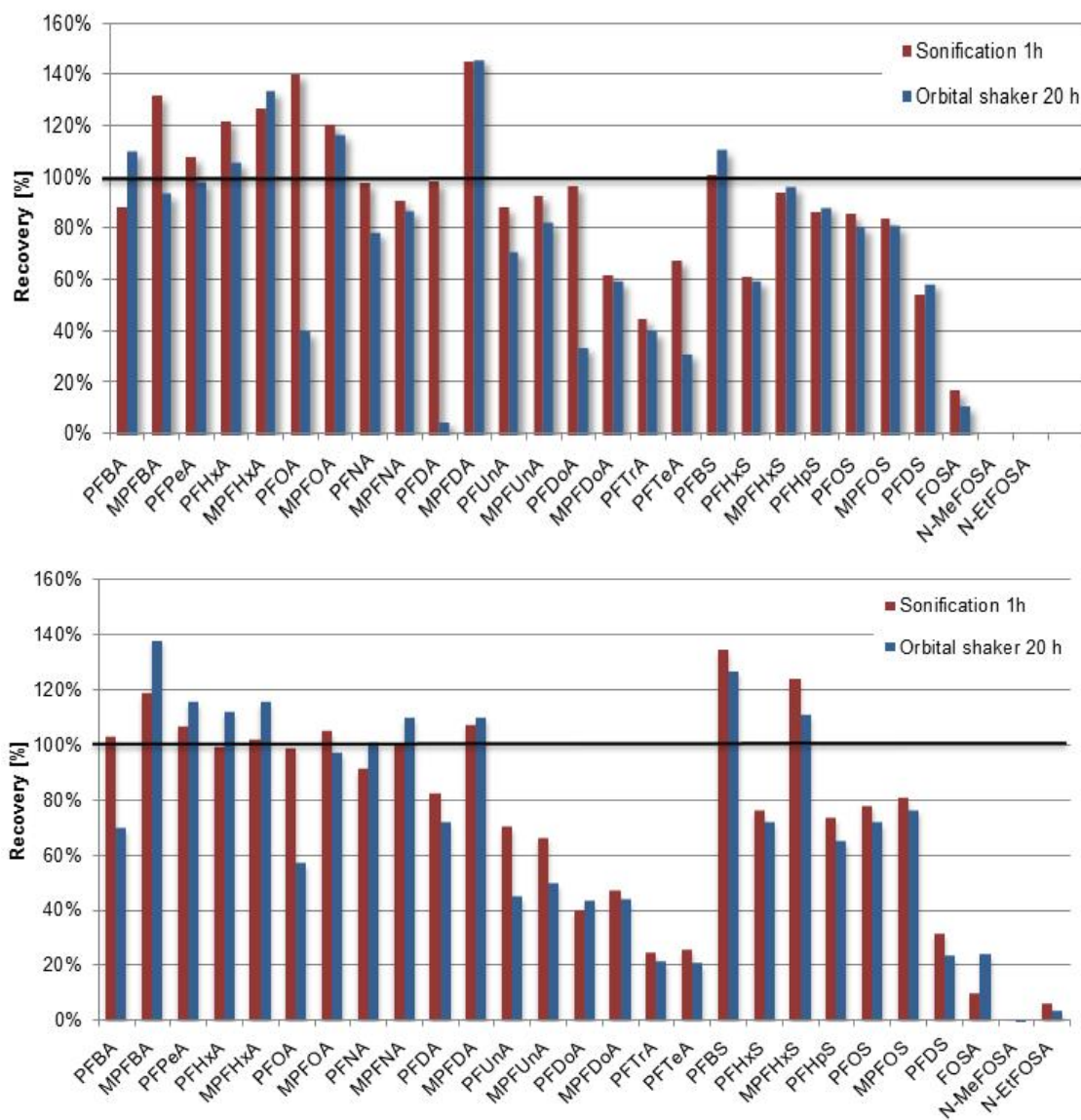

The results indicate that the method using 24 h shaking does not improve recovery rates significantly, therefore the method using 1 h sonication was chosen for further analysis in order to make the whole analytical procedure less time-consuming.

During the method development for FTOHs and FOSE compounds, the internal standard was initially applied to the pieces of textile in form of a methanolic solution. The extraction was initiated when the solvent was evaporated (optical inspection). However, regardless of the extraction method used, recoveries were extremely low. Thus, problems with recoveries for mass-labeled 8:2-FTOH were investigated more thoroughly.

In order to do so, 20  $\mu$ L MeOH containing 20 ng FTOHs and FOSE derivatives as well as mass-labeled 8:2-FTOH were pipetted into 16 1.5 mL Eppendorf reaction vials, respectively. The Eppendorf reaction vials were left open at room temperature. Two vials were filled immediately 500  $\mu$ L of MeOH and vortexed for 2 min. These two vials represented time point 0. After 60, 90, 105, 135, 150, 165 and 180 minutes, respectively two vials were filled with 500  $\mu$ L MeOH and vortexed for 2 min. The samples were transferred in polypropylene HPLC vials and measured by HPLC-MS/MS. Recovery was calculated by peak area comparison with the  $t_0$  samples. The results of this experiment are displayed in Figure 22.

Figure 22. Time course of FTOHs and FOSE species after application of a methanolic solution to an open vial showing the decline of FTOHs species by volatilization of the compounds after volatilization of the solvent [n=2].

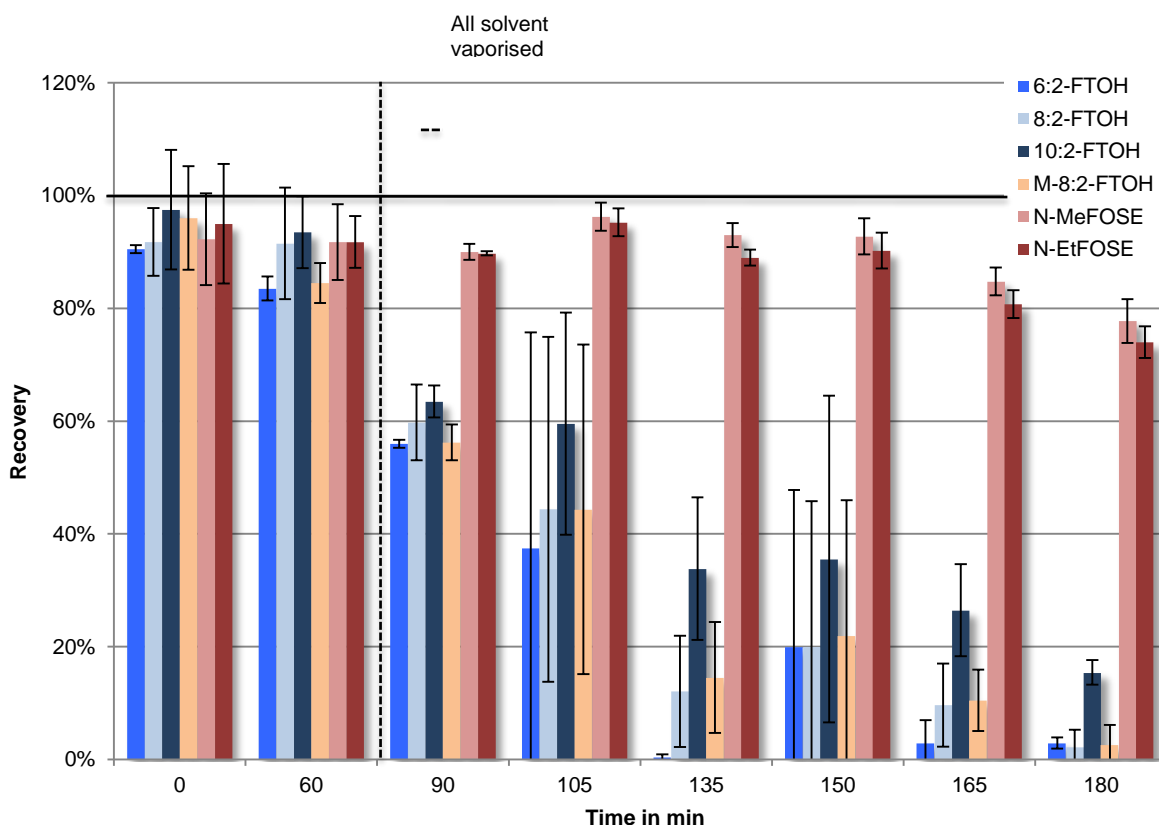

The results indicate a rapid decline in concentration for FTOHs already 30 min after evaporation of the solvent. The large error bars may stem from deviations in the evaporation velocity since the process of evaporation was not controlled. FOSE derivatives only showed a marginal decline of approximately 20% at the latest time point. These results suggest that an application of the internal standard, the mass-labeled 8:2-FTOH, is not feasible. It should be

pointed out that evaporation of the solvent is assumed to be accomplished more rapidly when the solution is spiked onto a piece of textile as compared with evaporation in a vial, which entails lower surface and less mass transfer with the surrounding air. As a result of these findings, spiking with internal standard was performed directly into the mixture of extraction solvent and jacket pieces.

The results also show that FTOH concentrations measured in jackets may be troubled and questionable if the textiles under investigation are not properly sealed. Residual FTOHs (and other volatile fluorinated residues) are assumed to evaporate from the treated textile which renders the comparison of results related to such compounds difficult.

### 12.7.2 Validation

Table 43. Calibration equations and correlation coefficients of LC-MS/MS calibration curves.

Compounds, <i>m/z</i> Q3	Equation	Correlation coefficient
PFBA, 213	$Y = 0.91 x + 0.0000361$	0.9936
PFPeA, 219	$Y = 0.551 x + 0.00000863$	0.9976
PFHxA, 269	$Y = 0.75 x + 0.000075$	0.9984
PFHxA, 119	$Y = 0.107 x + 0.0000115$	0.9972
PFHpA, 319	$Y = 1.13 x + 0.000814$	0.9972
PFHpA, 169	$Y = 0.383 x + 0.000204$	0.9970
PFOA, 369	$Y = 0.857 x + 0.00000721$	0.9974
PFOA, 169	$Y = 0.539 x + 0.0000118$	0.9967
PFNA, 419	$Y = 0.797 x + 0.0000103$	0.9975
PFNA, 169	$Y = 0.249 x + 0.0000103$	0.9961
PFDA, 469	$Y = 1.39 x + 0.0000762$	0.9966
PFDA, 269	$Y = 0.284 x + 0.00000685$	0.9953
PFUnA, 519	$Y = 0.909 x + 0.0000244$	0.9957
PFUnA, 319	$Y = 0.162 x + 0.0000437$	0.9957
PFDoA, 569	$Y = 0.666 x + 0.000076$	0.9954
PFDoA, 219	$Y = 0.127 x + 0.0000433$	0.9946
PFTTrA, 619	$Y = 0.667 x + 0.0000774$	0.9974
PFTTrA, 169	$Y = 0.21 x + 0.0000427$	0.9969
PFTeA, 669	$Y = 0.454 x + 0.0000522$	0.9914
PFTeA, 169	$Y = 0.124 x + 0.0000344$	0.9927
PFBS, 99	$Y = 0.448 x + 0.000121$	0.9974
PFBS, 80	$Y = 1.1 x - 0.0000301$	0.9954
PFHxS, 99	$Y = 0.412 x + 0.00000262$	0.9984
PFHxS, 80	$Y = 1.32 x - 0.00000554$	0.9986
PFHpS, 99	$Y = 0.303 x + 0.0000191$	0.9935
PFHpS, 80	$Y = 0.768 x - 0.0000142$	0.9949
PFOS, 99	$Y = 0.244 x + 0.0000229$	0.9972
PFOS, 80	$Y = 0.692 x - 0.0000186$	0.9971
PFDS, 99	$Y = 0.671 x - 0.0000121$	0.9923
PFDS, 80	$Y = 2.3 x - 0.0000974$	0.9946
FOSA, 78	$Y = 63100 x + 1.62$	0.9929
N-MeFOSA, 219	$Y = 5820 x + 0.00946$	0.9959
N-MeFOSA, 169	$Y = 77740 x + 1.94$	0.9961
N-EtFOSA, 219 <sup>1</sup>	$Y = 6160 x + 156$	0.9962
N-EtFOSA, 169 <sup>1</sup>	$Y = 11800 x + 1.54$	0.9946
6:2-FTOH, 59	$Y = 0.0133 x + 0.000297$	0.9969
8:2-FTOH, 59	$Y = 0.0337 x + 0.000742$	0.9981
10:2-FTOH, 59	$Y = 0.0563 x + 0.000141$	0.9975
N-MeFOSE, 59	$Y = 0.245 x + 0.000189$	0.9966
N-EtFOSE, 59	$Y = 0.309 x + 0.00236$	0.9974

Figure 23. Recovery of internal standards in selected jacket samples comprising all membranes and garments used in this study. Recovery was calculated based on peak area comparison in samples versus average peak area of internal standards in calibration standards.

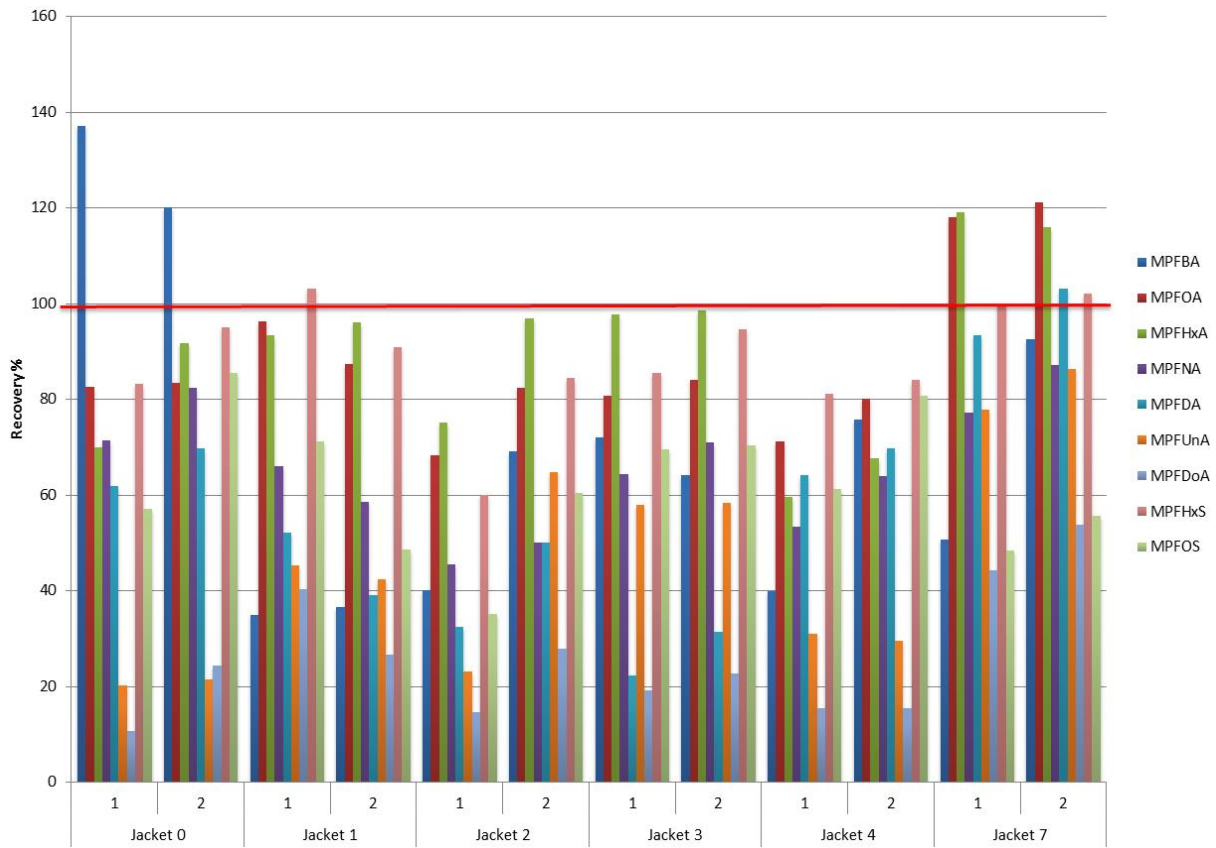



Understanding exposure pathways of PFASs via use of PFASs-containing products –risk estimation for man and environment

12.7.3 Results of DWR jacket analysis

Table 44: Concentrations of PFASs in outdoor jackets expressed in µg/kg; standard deviation (n=2) in brackets

	J0	J1	J2	J3	J4	J5	J6	J7	J8	J9	J10	J11	J12	J13	J14	J15
PFBA	n.d.	n.d.	n.d.	0.45 0.06	n.d.	n.d.	n.d.	n.d.	n.d.	n.d.	n.d.	1.81 0.20	n.d.	n.d.	n.d.	3.46 0.18
PFPeA	n.d.	0.06 (0.08)	< L00	0.38 0.02	< L00	n.d.	< L00	< L00	0.11 0.16	n.d.	n.d.	3.00 0.46	n.d.	n.d.	1.10 0.10	9.61 0.91
PFHxA	n.d.	0.35 (0.02)	2.83 (0.13)	3.32 (0.19)	0.65 (0.01)	0.07 (0.00)	0.73 (0.08)	1.71 (0.12)	1.56 (0.18)	2.28 (0.12)	0.12 (0.06)	2.43 (0.15)	n.d.	0.47 (0.00)	3.77 (0.41)	33.4 (2.45)
PFHpA																
PFOA	0.23 0.00	0.89 (0.06)	14.5 (0.39)	2.40 (0.24)	2.60 (0.06)	0.57 (0.00)	4.27 (0.02)	2.11 (0.20)	4.05 (0.06)	13.6 (0.43)	1.25 (0.06)	15.0 (1.47)	2.62 (0.36)	1.61 (0.03)	29.5 (1.82)	389 (66.7)
PFNA	< L00	0.14 (0.02)	1.54 (0.13)	0.33 (0.03)	0.35 (0.02)	0.22 (0.01)	0.40 (0.05)	0.33 (0.06)	0.34 (0.02)	1.17 (0.27)	0.29 (0.16)	6.87 (0.66)	0.18 (0.04)	0.47 (0.00)	22.9 (1.00)	62.9 (6.01)
PFDA	< L00	0.42 (0.08)	8.03 (0.15)	1.14 (0.15)	1.72 (0.05)	< L00	3.31 (0.08)	0.99 (0.05)	1.33 (0.40)	8.34 (0.29)	0.64 (0.13)	3.80 (0.39)	0.87 (0.19)	< L00	28.7 (6.98)	194 (8.24)
PFUnA	n.d.	n.d.	< L00	n.d.	< L00	n.d.	< L00	n.d.	n.d.	n.d.	n.d.	2.37 (0.26)	n.d.	n.d.	15.5 (1.25)	46.1 (1.89)
PFDoA	n.d.	< L00 -	3.65 0.52	0.47 0.00	1.94 0.49	n.d.	2.44 0.41	< L00	n.d.	n.d.	n.d.	n.d.	n.d.	n.d.	18.47 0.90	184 6.25
PFTrA	< L00	n.d.	n.d.	< L00	0.58 0.01	n.d.	0.13 0.01	n.d.	n.d.	n.d.	n.d.	n.d.	n.d.	n.d.	4.35 0.72	8.40 1.80
PFTeA	0.12 (0.20)	n.d.	0.43 (0.61)	0.28 (0.06)	1.39 (0.23)	n.d.	0.92 (0.07)	n.d.	n.d.	n.d.	n.d.	n.d.	n.d.	n.d.	2.89 (0.20)	46.5 (11.1)
PFBS	n.d.	n.d.	n.d.	n.d.	n.d.	n.d.	n.d.	n.d.	n.d.	n.d.	n.d.	n.d.	1.59 (0.11)	n.d.	n.d.	n.d.
PFHxS	n.d.	n.d.	n.d.	< L00	n.d.	n.d.	n.d.	< L00	n.d.	n.d.	n.d.	n.d.	0.01 (0.02)	n.d.	n.d.	n.d.
PFHpS	n.d.	n.d.	n.d.	n.d.	n.d.	n.d.	n.d.	n.d.	n.d.	n.d.	n.d.	n.d.	n.d.	n.d.	n.d.	n.d.
PFOS	n.d.	n.d.	n.d.	0.05 (0.01)	0.11 (0.00)	0.12 (0.03)	< L00	n.d.	n.d.	n.d.	n.d.	n.d.	0.14 (0.01)	n.d.	n.d.	1.22 (0.18)

Understanding exposure pathways of PFASs via use of PFASs-containing products –risk estimation for man and environment

	J0	J1	J2	J3	J4	J5	J6	J7	J8	J9	J10	J11	J12	J13	J14	J15
<b>PFDS</b>	n.d.	n.d.	< L00	n.d.	n.d.	n.d.	n.d.	n.d.	n.d.	n.d.	n.d.	n.d.	n.d.	1.54 (2.26)	n.d.	0.73 (0.50)
<b>FOSA</b>	< L00	n.d.	n.d.	< L00	< L00	< L00	< L00	< L00	n.d.	n.d.	n.d.	< L00	< L00	0.30 0.42	n.d.	< L00
<b>N- MeFOSA</b>	n.d.	n.d.	n.d.	n.d.	n.d.	n.d.	n.d.	n.d.	n.d.	n.d.	n.d.	n.d.	n.d.	n.d.	n.d.	n.d.
<b>N-EtFOSA</b>	n.d.	n.d.	n.d.	n.d.	n.d.	n.d.	n.d.	n.d.	n.d.	n.d.	n.d.	n.d.	n.d.	n.d.	n.d.	n.d.
<b>10:2- FTOH</b>	< L00	10.7 (1.50)	124 (12.6)	< L00	16.3 (0.29)	44.7 (1.00)	14.5 (1.39)	13.8 (3.33)	43.4 (9.08)	41.8 (3.06)	57.7 (12.5)	45.9 (9.57)	6.57 (0.33)	71.6 (1.46)	1191 (62.7)	16.69 (1.42)
<b>6:2-FTOH</b>	n.d.	n.d.	10.8 (1.94)	< L00	< L00	< L00	n.d.	153 (28.3))	< L00	< L00	< L00	< L00	< L00	< L00	< L00	< L00
<b>8:2-FTOH</b>	< L00	19.2 (0.24)	343 (42.4)	5.59 (0.74)	120 (9.14)	81.8 (21.3)	135 (48.8)	32.3 (4.23)	138 (7.50)	125 (16.8)	375 (13.7)	216 (38.8)	23.1 (1.50)	279 (12.6)	3369 (0.3)	21.9 (1.69)
<b>N-MeFOSE</b>	< L00	< L00	< L00	< L00	< L00	< L00	n.d.	n.d.	n.d.	0.52 (0.16)	1.72 (0.08)	1.65 (0.26)	n.d.	< L00	10.1 (0.35)	11.6 (0.20)
<b>N-EtFOSE</b>	n.d.	< L00	< L00	< L00	< L00	n.d.	n.d.	n.d.	n.d.	n.d.	n.d.	n.d.	1.13 (0.23)	0.05 (0.07)	< L00	n.d.
<b>Sum</b>	0.35	31.7	500	14.4	145	127	162	76.8	189	193	76.1	80.7	11.5	62.8	897	997

## 12.8 Analysis of impregnating agents

Figure 24. Recovery of M-8:2-FTOH in diluted impregnating agents and wash-in impregnating agents without SPE.

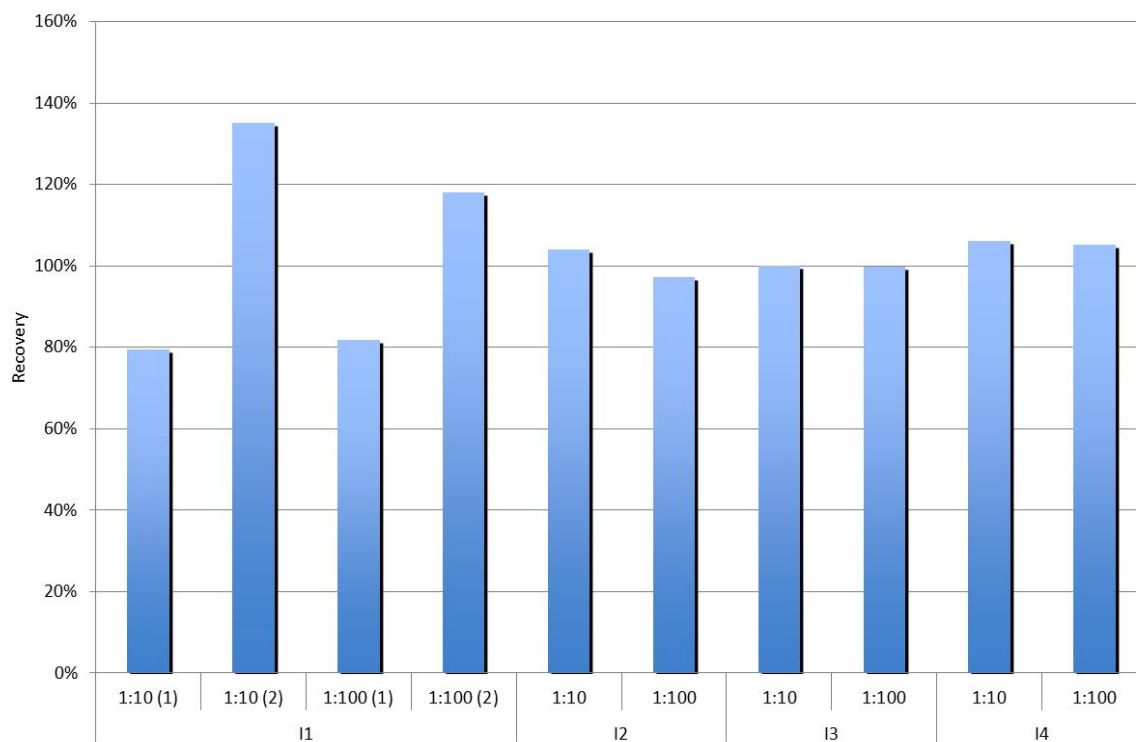

## 12.9 Analysis of emissions

Since PFAS-n analysis is based on the rather non-selective MRM transitions  $[M+CH_3COO] \rightarrow CH_3COO^-$ , all of the eluates of the evaporation tests were spiked with 100 ng/mL of PFAS-n to determine the recovery and thus the trueness of the measurement. The resulting recoveries are summarized in Table 45.

Table 45: Recovery of PFAS-n (100 ng/mL) spiked to the eluates of evaporation tests (n=2) to determine trueness

	J2		J8		J10		J14	
	Mean	SD	Mean	SD	Mean	SD	Mean	SD
6:2-FTOH	105	4.2	108	3.5	105	6.4	116	9.2
8:2-FTOH	104	7.9	104	5.3	104	5.0	101	5.7
10:2-FTOH	110	25.7	116	2.5	118	10.2	140	7.8
N-MeFOSE	98.2	4	98.8	3.0	98.4	3.6	111	15.9
N-EtFOSE	104	10.6	108	4.2	111	6.4	132	11.3

Table 46. Individual data for evaporation studies using J14 and . Concentrations given in ng/mL in the SPE eluates. Flask A and B refer to duplicate measurements; Air was collected for 5 days.

		Flask A	Flask B	Average	Blank	Average A/B corrected by blank
J10	6:2 FTOH	n.d	n.d	n.d	n.d	n.d
	8:2 FTOH	23.7	25.7	24.7	3.4	21.3
	10:2 FTOH	16.9	14.9	15.9	2.2	13.7
	N-MeFOSE	n.d	0.286	0.143	0.773	n.d
	N-EtFOSE	n.d	0.231	0.116	0.83	n.d
J14	6:2 FTOH	n.d	n.d	n.d	n.d	n.d
	8:2 FTOH	202	224	213	3.4	209.6
	10:2 FTOH	236	257	246.5	2.2	244.3
	N-MeFOSE	0.652	0.897	0.775	0.773	n.d
	N-EtFOSE	0.793	1.68	1.24	0.83	0.407

Table 47. Individual data for evaporation studies using J14 and. Concentrations given in ng/mL in the SPE eluates. Flask A and B refer to duplicate measurements; SPE1 was collected for 5 days, SPE2 was collected for a further 2-day period

		Flask A SPE1	Flask A SPE2	Flask B SPE1	Flask B SPE2	Average Flask A/B (SPE1+SPE2)	Blank	Average A/B(SPE1 + SPE2)corrected by blank
J2	6:2 FTOH	0.574	4.28	3	6.33	7.09	n.d	7.09
	8:2 FTOH	36.4	n.d	32.8	0	34.6	n.d	34.6
	10:2 FTOH	57.9	n.d	56.3	0.111	57.2	0.252	56.9
	N-MeFOSE	0.288	0.225	0.308	0.209	0.515	0.357	0
	N-EtFOSE	0.164	0.105	0.107	0.119	0.248	0.223	0
J8	6:2 FTOH	n.d	n.d	n.d	1.86	0.93	n.d	0.93
	8:2 FTOH	63	n.d	53.7	0	58.4	n.d	58.4
	10:2 FTOH	84.7	n.d	74.5	0.267	79.7	0.252	79.5
	N-MeFOSE	0.421	0.21	0.383	0.236	0.625	0.357	0.268
	N-EtFOSE	0.315	0.117	0.316	0	0.374	0.223	0.151

Understanding exposure pathways of PFASs via use of PFASs-containing products –risk estimation for man and environment

Table 48: LOQs and LODs for PFAAs in washing water; high values are a result of high background signals in the washing water

	LOQ (ng/L)	LOD (ng/L)
PFBA	54.6	18.2
PFPeA	60.6	20.2
PFHpA	132	43.9
PFHxA	85.2	28.4
PFOA	195	65.2
PFNA	5.87	1.96
PFDA	32.8	10.9
PFUnA	2.51	0.84
PFDoA	177	58.8
PFTTrA	31.5	10.5
PFTeA	0.00	0.00